

Comprehensive training material for local consultants and auditors Thangadh ceramic cluster

GEF-UNIDO-BEE Project Promoting Energy Efficiency and Renewable Energy in selected MSME clusters in India

Prepared for:



Bureau of Energy Efficiency

©Bureau of Energy Efficiency, 2018

This document has been originally prepared by TERI as a part of 'Capacity Building of LSPs' activity under the GEF-UNIDO-BEE project 'Promoting Energy Efficiency and Renewable Energy in selected MSME clusters in India'.

Suggested Format for Citation

This document may be reproduced in whole or in part and in any form for educational and non-profit purposes without special permission, provided acknowledgement of the source is made. BEE and TERI would appreciate receiving a copy of any publication that uses this document as a source. A suggested format for citation may be as below:

GEF-UNIDO-BEE Project, Bureau of Energy Efficiency, 2018

“Capacity Building of Local Service Providers”

For more information

GEF-UNIDO-BEE PMU

Bureau of Energy Efficiency

4th Floor, Sewa Bhawan, Sector-1,

R.K. Puram, New Delhi-110066

Email: gubpmu@beenet.in

pmc@teri.res.in

Website: www.beeindia.gov.in

www.teriin.org

Disclaimer

This document is an output of an exercise undertaken by TERI under the GEF-UNIDO-BEE project's initiative for the benefit of MSME units and is primarily intended to assist the decision making by the management of the intended unit for

the proposed technology. While every effort has been made to avoid any mistakes or omissions, GEF, UNIDO, BEE or TERI would not be in any way liable to any person or unit or other entity by reason of any mistake/omission in the document or any decision made upon relying on this document

Contents

About this manual.....	1
1.0 Introduction.....	1
1.1 Background	1
2.0 Module 1 - Energy Efficiency and Renewable Energy Technologies.....	3
2.1 EE and RE technologies	3
2.2 Government Schemes and Policy.....	19
3.0 Module 2 - Energy efficient and Renewable Energy (EE/ RE) Technologies & BoPs.....	21
3.1 Best operating practices (BoPs)	21
4.0 Module 3 - Kiln (Burner, automation and waste heat recovery).....	31
4.1 Drying Process and Equipment	31
5.0 Module 4 - Financing schemes and DPR preparation for EE projects.....	43
5.1 Introduction.....	43
5.2 Major financial schemes for MSMEs in India.....	46
5.3 Various credit lines and bank schemes for financing of EE	48
5.4 Preparation of detailed project report (DPR)	49
5.5 Step by step approach for loan application	51

About this manual

This manual provides, in a direct and simple manner, guidance on improving energy efficiency for local service providers (LSPs) in the 'Local consultants and auditors' category.

The aim is to build their capacities and equip them with the necessary knowledge and skills and to provide background information and tips regards energy efficiency (EE)/renewable energy (RE) options in important ceramic manufacturing process viz. energy efficiency and renewable energy technologies, energy efficient and renewable energy (EE/ RE) technologies & BoPs and Kiln (Burner, automation and waste heat recovery). A separate module on Financing schemes and DPR preparation for EE projects has been added to build the capacities of LSPs on preparation of bankable DPRs.

The manual is designed to complement the knowledge shared with the participants through a series of four one day training/capacity building programs undertaken by TERI in Thangadh Ceramic Cluster between January to May 2018 under the GEF-UNIDO-BEE Project "Capacity Building of Local Service Providers".

1.0 Introduction

1.1 Background

The overall aim of the GEF-UNIDO-BEE project is to develop and promote a market environment for introducing energy efficiency and enhancing the use of renewable energy technologies in process applications in selected energy-intensive MSME clusters in India. This would help in improving the productivity and competitiveness of the MSME units, as well as in reducing the overall carbon emissions and improving the local environment.

The following three ceramic clusters are targeted under the assignment - Thangadh, Morbi and Khurja.

This comprehensive training material for Thangadh ceramic cluster is targeted at 'local consultants and auditors' category. The material is structured in the following 4 modules.

Module 1	Energy Efficiency and Renewable Energy Technologies
Module 2	Energy efficient and Renewable Energy (EE/ RE) Technologies & BoPs
Module 3	Kiln (Burner, automation and waste heat recovery)
Module 4	Financing schemes and DPR preparation for EE projects

2.0 Module 1 – Energy Efficiency and Renewable Energy Technologies

2.1 EE and RE technologies

2.1.1 Energy conservation of thermal energy

Considering the fuel reserves and increasing competition, it is essential to adopt energy conservation measures to improve overall efficiency, reduce operating cost/production cost and minimise the load on energy resources. The efficiency of a kiln will depend on how efficient the combustion system is and secondly how best the generated heat is utilized. Use of standard and good quality fuel improves overall performance of the firing system. Around 5 - 15% energy saving is possible from kilns used in ceramic industries. Some of the potential energy conservation measures (ECMs) for thermal system are listed below.

- Optimum kiln design to ensure capacity utilization to the tune of 98%
- Use of optimum product thickness to reduce heat load for sintering
- Complete combustion with minimum excess air.
- Proper heat distribution.
- Operating the kiln at desired temperature.
- Reducing heat losses from the openings.
- Minimizing wall losses by improving kiln insulation.
- Waste heat recovery from fuel gasses and utilization for drying green products
- Control of Chimney draught and kiln pressure
- Use pre-heating of spray dryer input slurry either solar or electrical heat pump
- Biomass / briquette firing in hot air generation
- Fuel switch over with better option in spray dryer
- Switching to continuous type kilns from intermittent type
- Adopting best operating practices including optimizing of excess air levels
- Use of hot air from cooling zone to preheat input material
- Energy efficient burner that can handle pre-heated combustion air at higher temperature
- Arresting air infiltration in kilns and spray drier system
- Use of lubricants and proper maintenance

Application of ECMs and absolute energy saving would largely depend on the base case scenario and relevant parameters likes operating efficiency of equipment, operating hour, operating load, landing fuel price etc. Some of the applications of ECMs are described below.

Use of low thermal mass material in kiln fabrication and material movement

Heavy refractory cars and saggars are generally used for carrying ceramic products inside the kiln. The dead weight of the refractories is quite high (around 24%). These refractories

which do not take part in reactions in formation of ceramic products, are subjected to alternate heating and cooling cycles, thereby losing substantial portion of heat input. These heavier refractory cars and saggars can be replaced effectively with low thermal mass cars and decker plates (23 - 24 % weight reduction is possible), which would help in reducing heat losses substantially. The estimated energy saving with use of low thermal mass cars is about 5-10%.

- Use of low thermal mass for kiln cart to **reduces the thermal weight** of the kiln considerably
- Weight reduction in kiln car saves significant amount of energy and also **improve material to car weight ratio**
- Reduces excess the **thermal energy storage** in the kiln furniture (**Roller**)
- Ultralite insulating material with supporting block gives proper support and increase the strength of the kiln base
- Replacing refractory bricks with hollow ceramic coated pipes at the supporting pillars for holding racks
- Dead weight can be cut down to 15 to 25% of the existing weight

Advantages of ultralite insulating material

- High open porosity
- Low thermal mass
- Low permeability
- Low thermal conductivity
- Low bulk density
- Lightweight



Maintain the required air to fuel ratio for proper combustion of fuel

Kilns are important segment in ceramic industries and accounting for about 50-65% of energy consumption. Various operating parameters such as temperatures, draft, retention time and material arrangement, etc. may vary with the type of kilns used. More the air is used to burn the fuel, more is the heat wasted in heating air. Air, slightly in excess of ideal stoichiometric (or theoretical) fuel to air ratio is required for complete combustion and to reduce NOx emissions; it is dependent on the type of fuel. However, excess air beyond the optimum range (an efficient natural gas burner however requires 2% to 3% excess oxygen, or 10% to 15% excess air in the flue gas, to burn fuel without forming carbon monoxide) may substantially decrease combustion efficiency as it leads to generation of excessive waste gases. The effect of excess air level and flue gas temperature on dry flue gas losses is shown in graph

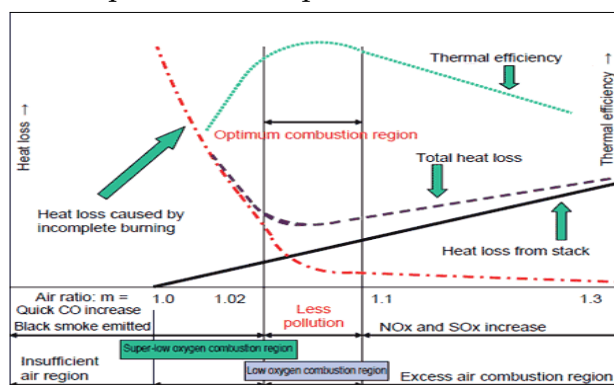

The relationship between the air-to-fuel ratio and wasted heat energy provides a basis for control system design. In most of the cases, real combustion processes have inadequate mixing of air with fuel. Also, the gases tend to flow so quickly that the air and fuel mix have limited contact time in the combustion zone. As such, if air is fed in exact theoretical or stoichiometric proportion to the fuel, it will still lead to incomplete combustion. Automatic burner assembly generally performs in a manner similar to the graph. The cost associated with operating at increased air-to-fuel ratio is the energy wasted in heating additional air volume. Yet, if the air-to-fuel ratio is decreased, losses due to incomplete combustion and emission will increase rapidly.

Kiln thermal parameters controller comprises kiln temperature, pressure and atmosphere controlling. In different stages, the control act differently, in firing process, PLC control inverter adjust the combustion fan to change air flowing in air hose. Electric valve of fire nozzle is set by numerical program to setup kiln atmosphere during heating process.

In the cooling stage, NG is shut down and each fire valves/nozzle is closed automatically. The temperature controller switch to the cooling control mode and the system enters cooling stage. In this period, air general pipe is controlled by opening degree.

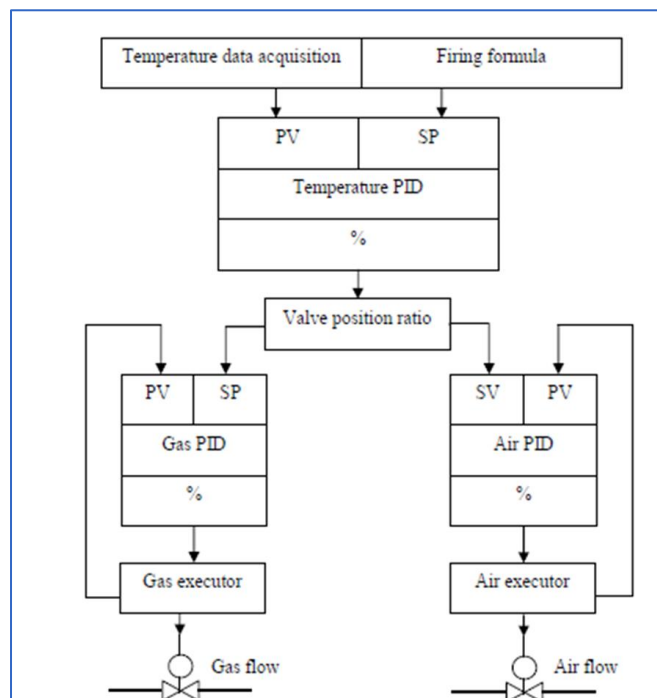

Fire nozzles are divided into two groups. In order to reduce cost, temperature valve position automatic control is used as shown in Figure. Each gas general hose has gas solenoid valve and each group of gas general hose and combustion general hose is installed with electric executor. This compares the air-fuel ratio practical value (PV measured by thermocouples) with set value (SV) and controls gas executor and combustion executor by PID regulator. Temperature PID controller controls firing by controlling air flow and gas flow which are accomplished by the opening degree of combustion air valves and gas valves. The benefits of combustion control system will be:

- Reduce excess fuel consumption.
- Reduce blower power consumption
- Increases exhaust temperature
- Give higher benefits in preheated combustion air as well as in dryer applications

Reduction of the excess air flow rate leads to a reduction in kiln energy consumption, though this operation must be performed with care, because other kiln operating parameters could be affected. It has been experimentally verified that 2% reduction in the oxidising air flow rate entails a decrease of the order of 5% in the natural gas flow rate.

(Source: Manual on Energy Conservation Measures in Ceramic Industry, BEE SME Programme)

Improved insulation of kiln

The heat loss from a kiln structure can be divided into (i) radiation loss through openings and surface of the body, (ii) heat accumulation loss to internal insulation and supports composing the body. Improvement in the radiation heat loss from surfaces can be achieved by reinforcing its insulation. This includes (i) covering of internal wall surface with ceramic fibre insulation, and (ii) covering external wall surface with ceramic fiber or rock wool insulation.

The temperature gradient i.e. difference between the hot face temperature (hot face temperature is the temperature of the surface in contact with the flue gas or heated combustion air) and surface temperature will be a critical factor for reduction in heat loss by reinforcement of insulation. The hot face temperature is used to determine refractory or insulation thickness and heat transmitted. The design temperature is used to specify the service temperature limit of refractory materials.

The potential energy savings for insulating the firing zone of kiln may be up to 2-5%. However the capital investment required for reinforcement of insulation may be higher

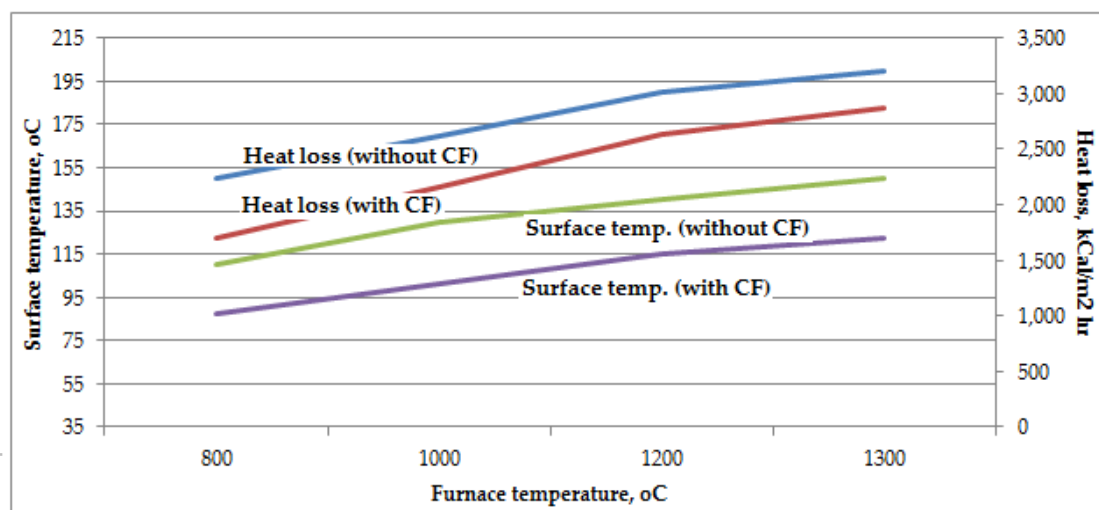
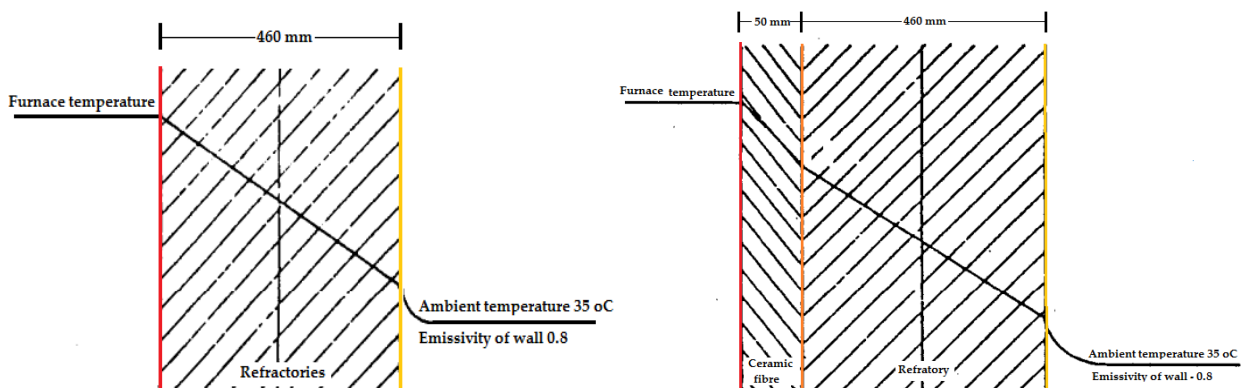

Effect of insulation in a kiln: Heat loss vs surface temperature

indicating long payback period.

Use of hot air of cooling zone of kiln directly as a combustion air

Hot air from cooling zone of kiln has a temperature of about 250-300 °C. Use of this hot air directly for combustion of fuel (NG or PG) can result in significant savings in fuel consumption in the kiln.

(Source: Manual on Energy Conservation Measures in Ceramic Industry, BEE SME Programme)

Use of energy efficient & high preheated air temperature burners

Use of high velocity energy efficient burner's and high preheated air temperature burners further improves kiln efficiency. Observed maximum preheated air temperature in the kiln in Thangadh cluster is 250 °C, whereas current burner technology accepts air preheat temperature upto 600 °C. This offers good opportunity for high temperature waste heat recovery. Higher the combustion air temperature, lower will be the fuel consumption in the kiln.

(Source: Manual on Energy Conservation Measures in Ceramic Industry, BEE SME Programme)

Energy conservation of electrical energy

Share of electrical energy consumption may be less but absolute quantity is very high. There are cost effective feasible measures, which could reduce energy consumption in ceramic industries. Some of the potential ECMs to save electrical energy are mentioned below.

- Continuous multi-stage or vibro ball milling system to replace conventional ball milling / blunger
- Installation of load sensor on conveyor belt to control auto on off depending upon the load availability on the belt
- Energy efficient motors with VFD for variable load applications or demand fluctuates like ball mill, blunger, agitating tank, dedusting and centralize vacuum cleaning, compressor, belt conveyor etc.
- Cogeneration system to reduce electrical as well thermal energy consumption
- Automatic hydraulic press system with interfacing and interlocking to switch off chiller system when hydraulic press is non-operative
- avoid idle operation of hydraulic press pump
- Auto interlock between brushing dust collection blowers and glazing lines
- Energy efficient utilities and lighting system
- Switch over electrical heating system to low cost primary fuel heating system
- Sensor based intelligent water tap
- Level controller for water pumping system for auto on -off

Some of the applications of ECMs are described below.



Application of energy efficient motors & VFDs

Generally, most of the existing motors in ceramic industries are age old and very inefficient due old model apart from wear and tear in use. The electrical energy conservation measures in a ceramic unit include use of energy efficient motors in polishing area, replacement of smaller motors with a single large motor, adopting energy efficient motors and VFD (variable frequency drives) in agitating tanks, material conveyor, spray dryer, kiln blower, press and compressor sections and use of energy efficient hydraulic pumps. These measures would help in achieving energy saving between 8-15%.

Replacement of V belts by energy efficient flat belts

Replacement of V-belts with flat belts or grooved V-belts can typically save 4-6% of the transmitted energy. There is potential for these savings in ball mills & agitators.

(Source: Manual on Energy Conservation Measures in Ceramic Industry, BEE SME Programme)

Energy efficiency in compressed air system

Compressed air is used widely in ceramic industry and is often considered the “fourth utility” at many facilities. It is further extremely inefficient at part load. Improving and maintaining compressed air system performance requires not only addressing individual components, but also analyzing both the supply and demand sides of the system and how they interact. Various energy saving opportunities to optimize the compressed air use and electricity consumption are as follows:

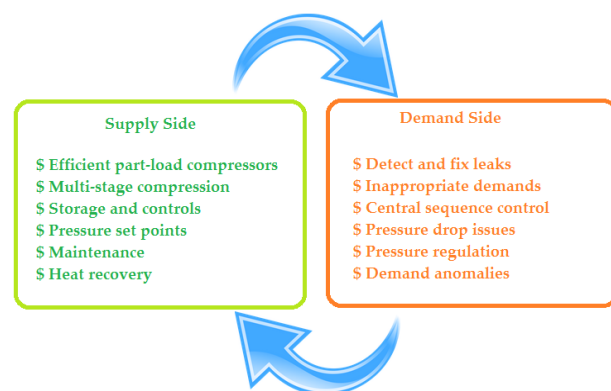

Supply and demand sides of compressed air system

Review air demand: Before taking initiatives to improve the compressed air system, it is necessary to determine the air demand or requirements of the manufacturing facility. To obtain demand profile, the air delivery from compressor section must be measured at various points over a period of time (to take care of load variations). It is also necessary to monitor system pressure and power consumption at the same points and time in order to see how the flow, pressure and power consumption change over time. This profile should be obtained over a typical production cycle so that demand on compressed air system can be seen at all stages.

The air compressors provided in rolling industries mainly use load/unload mode (online/offline control) of operation. During unload condition, it keeps the motor running continuously, but unloads the compressor when the discharge pressure is adequate. Unloaded power consumption of air compressor is significant of their full load power

demand (Screw: 30-40% and Reciprocating: 15 -20%), while producing no useful compressed air output.

To minimize the electricity consumption during unload, variable speed option is an appropriate solution. VSD enabled compressors should be considered for trim (or swing) duty as they are typically the most efficient control mechanism to cater to partial loads. Capable of supplying a constant pressure through a wide control range, energy consumption and flow of a VSD compressor is almost directly proportional to the speed. This can result in energy savings over comparable fixed speed units when compressors are partially loaded.

Pressure profile: Higher the generation pressure of compressed air, higher will be the power consumption. Different tools and process operations require different pressures. Required pressure levels must take into account system losses from dryers, separators, filters, and piping.

A rule of thumb, for every 2 psi increase in discharge pressure, energy consumption will increase by approximately 1 percent at full output flow.

There is also another penalty for higher-than-needed pressure. Raising the compressor discharge pressure increases the demand of every unregulated usage, including leaks, open blowing, etc.

Set pressure = maximum pressure required at end use + minimum pressure drop

Compressed air system leaks: Compressed air leaks can be a significant contributor of wasted energy in a compressed air system, and in some instances lead to productivity losses. It is not unusual to encounter 20-40% of a compressor’s output as air leaks in typical industrial facilities. Although leaks can occur in any part of the distribution system, the most common areas/ points of leaks include couplings, hoses, tubes, fittings, pipe joints, quick disconnects, filters, regulators, lubricators, condensate traps, valves, flanges, packing, thread sealants and points of use devices.

Leakage rates are a function of the supply pressure in an uncontrolled system and increase with higher system pressures. Leakage rates are also proportional to the square of the orifice diameter (refer table). Proper installation and preventive (detection and repair) maintenance of compressed air distribution network and associated system can reduce leaks to less than 10% of a plant’s compressed air generation.

Leakage rates* (cfm) for different supply pressure and approximately equivalent office sizes						
Pressure (psig)	Office Diameter (inches)					
	1/64	1/32	1/16	1/8	1/4	3/8
70	0.3	1.2	4.8	19.2	76.7	173
80	0.33	1.3	5.4	21.4	85.7	193
90	0.37	1.5	5.9	23.8	94.8	213
100	0.41	1.6	6.5	26.0	104	234
125	0.49	2.0	7.9	31.6	126	284

*For well-rounded orifices, multiply the values by 0.97, and for sharp-edged orifices, multiply the values by 0.61.

In addition to being a source of wasted energy, leaks can also be reasons to other operating losses. There is strong “cause and effect” relationship between the number and magnitude of air leaks with

the overall compressed air system pressure. For example, lower air pressure can affect air tools and equipment by reducing the mechanical output and decreasing the productivity.

An ultrasonic leak detector is probably the most appropriate equipment to detect air leakages. An ultrasonic sensor focuses on the ultrasonic elements in the noise. Because ultrasound is a short wave signal, the sound level will be loudest at the leak site. These detectors are generally unaffected by background noises in the audible range because these signals are filtered out.

Energy efficiency in distribution transformers

After transmission and distribution of electrical energy, facility level distribution transformers represent the next highest source of energy losses. Distribution transformers are relatively easy to replace and manage (in comparison with other technologies used in industrial facilities), and the efficiency can be easily measured and sustained. Taking life cycle cost into account, installation of high efficiency transformers is an economically sound investment despite higher initial cost. Other benefits include reduced emissions, improved reliability and potentially longer service life.

▪ **Ultra-high efficiency transformers:**

Transformers are continuous operating system for any facility and therefore reduction in losses is a matter of importance. The development in transformers in last decade has led to the appearance of ultra-high efficiency transformers, which have lower energy losses as compared to conventional transformers. To reduce the iron losses (no-load losses), following iron core material technologies have been developed:

- High-orientation silicon steel sheet
- Laminated iron core of thinner silicon steel coil material
- Magnetically segmented silicon steel coil sheet
- Amorphous iron cores

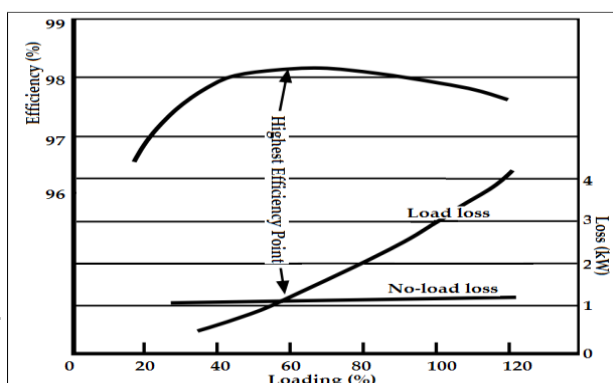
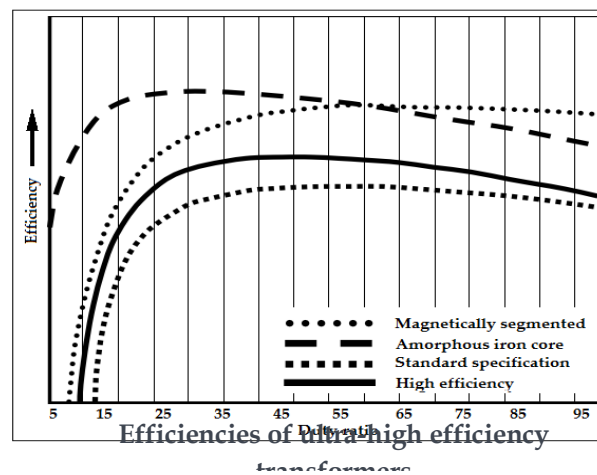

No-load and load losses in transformers

With the use of efficient iron core materials, a no-load loss reduces considerably in comparison to transformers using conventional core material. Other advantages of ultra-high

efficiency transformers include no fire risk, no risk of escape of pollutants or fire-hazardous substances, long lifetime, high mechanical strength and reduced emissions.

Power management system / transformer quantity controller: There are two types of transformer losses, i.e. no-load loss and load loss (copper loss). The no-load losses are certain amount of losses regardless of the existence of load on the transformer. If there are one or more transformers with same primary and secondary voltage, the total losses may be optimized by shifting the load of low load transformer to other transformer.

To achieve the maximum benefits of parallel transformer system, PLC based power management system (PMS) may be adopted. The transformer can be operated with highest possible efficiency when the no-load loss and the load loss become equal. Therefore, if one or more transformers are operated in parallel and if the load is fluctuating, PMS controls the losses by adhering to efficiency characteristic of each transformer and automatically controls the number of transformers and the combination of the transformers required according to the load fluctuation.

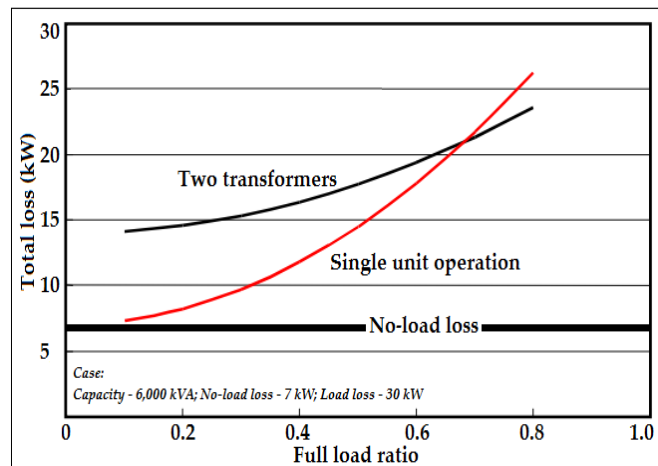

Parallel operation of transformers

2.1.2 Replacing existing Fans with BLDC fans

The drying of the mould in the chambers/rooms are through the ceiling fans are provided at the top to circulate the air in the chamber/moulds. It was observed that the moulding chambers/rooms are equipped with conventional ceiling fans of 75 watt each. There is a substantial difference in power consumption between conventional fans and energy efficient fans.

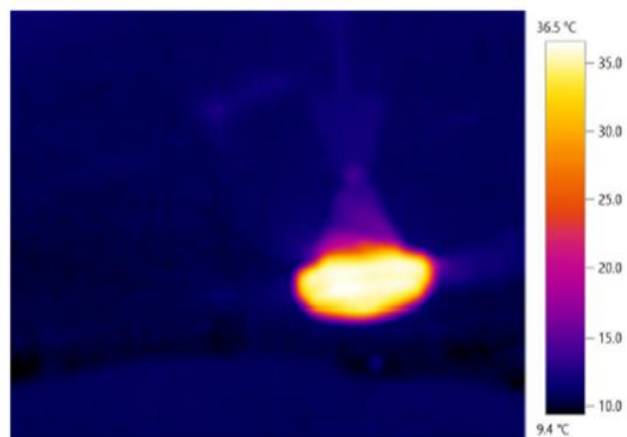

Thermal image of ceiling fan

Compared to conventional induction fan, energy efficient brush less DC (BLDC) fan consumes 28 watt to deliver the same amount of the air volume and because there is no heating of the motor, minimal addition of heat in the chamber (75% less heat than a conventional unit) and the life of a BLDC fan is also expected to be much higher than

ordinary fans. A comparison of power consumption of the existing fans with the super fans at different speed levels is shown in figure below.

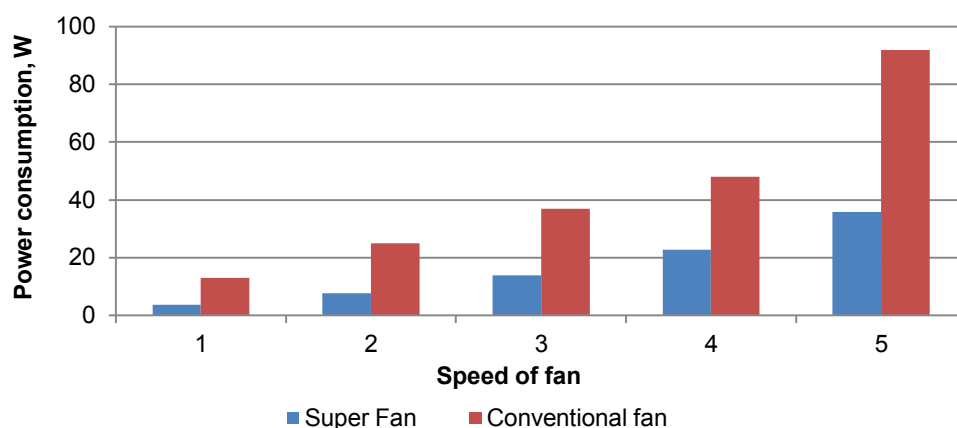

Power consumption: Conventional fan v/s BLDC fan

It is recommended to replace the existing fans with energy efficient BLDC fans in chambers, ante room and common areas.

Lighting system

In ceramic units, energy consumption for illumination also has considerable share. Typical method to optimize energy use in lighting may be upgradation of existing system or adoption of new and efficient technologies. The use of automation in the existing facility may save up to the extent of 50% of energy use by providing the right amount of light. These control system can also help to provide safer, more productive work environment.

Product	The initial purchase cost for the lighting system	Beyond first cost, compare performance: service life, lumen maintenance, and color rendering and stability
Energy	Annual operating hours multiplied by electrical cost	Consider product wattages as well as light output & lamp performance
Maintenance	Includes manpower and relamping costs	Longer-life lamps that maintain colour stability and lumen output can reduce maintenance
Disposal	The end-of-life cost, including disposal and recycling of lamps, ballasts and fixtures	Another area where longer-life lamps benefit industrial facility owners, by reducing waste and cost

High efficiency lamps and ballasts, new and efficient light technologies (LED, Induction lamps, compact fluorescent lamps etc.) and use of reflectors may lead to significant reduction in operational cost.

Lighting control: Quality lighting is an important aspect in steel rolling industries, and is often an ignored area. Light control has the ability to regulate the level and quality of light in a given space for specific tasks or situations. The lighting control systems include timer and inverter based dimmer control systems to

Lamp type	Lumens per watt	Rated life (hours)	Color rendering index, CRI	Color temperature, °K
T8 high-performance fluorescent with electronic ballasts	86 – 96+	24,000 to 42,000+	80 to 85	3,000 to 6,500
T5 with electronic ballasts	86 – 96+	30,000 to 40,000	80 to 85	3,000 to 5,000
T5HO with electronic ballasts	86 – 96+	30,000 to 40,000	80 to 85	2,700 to 5,000
Compact fluorescent lamps (hard-wired)	43 – 71	6,000 to 12,000	80 to 85	2,700 to 5,000
LED replacement lamps	50 – 100+	25,000 to 50,000+	80 to 90+	2,700 to 6,000+
LED, new fixtures	Up to 100+	50,000 to 100,000	80 to 90+	2,700 to 6,000+
Electronic HID	60 – 80	20,000	65 to 90	2,900 to 4,000
Induction (filament less)	60 – 75+	100,000	80 to 90+	3,000 to 4,000+

optimize the use of daylight operation. Optimum control of task specific lighting not only enhances the comfort level of work stations but it also helps to save energy by using light when and where it is needed most.

High efficiency lighting: Recent technological advancements have introduced a new era of energy efficient lighting products. Replacement of the existing lighting with most advanced light sources and fixtures may save upto 50% on lighting energy use, while benefiting from the best in lighting quality. Energy efficient lighting offers additional benefits such as reduced load on air conditioning and ventilation system, better life and is compatible with advance control & automation.

Power factor

Power factor is the percentage of electricity that is being used to do useful work. It is defined as the ratio of ‘active or actual power’ used in the circuit measured in watts or kilowatts (W or kW), to the ‘apparent power’ expressed in volt-amperes or kilo volt-amperes (VA or

$$\text{Power factor} = \frac{\text{Active Power}}{\text{Apparent Power}}$$

kVA).

The apparent power also referred to as total power delivered by utility company has two components.

1. ‘Productive Power’ that powers the equipment and performs the useful work. It is measured in kW (kilowatts)
2. ‘Reactive Power’ that generates magnetic fields to produce flux necessary for the operation of induction devices (AC motors, transformer, inductive furnaces, ovens etc.). It is measured in kVAR (kilovolt-Ampere-Reactance).

Reactive Power produces no productive work. An inductive motor with power applied and no load on its shaft should draw almost nil productive power, since no output work is being accomplished until a load is applied. The current associated with no-load motor readings is almost entirely "Reactive" Power. As a load is applied to the shaft of the motor, the "Reactive" power requirement will change only a small amount. The ‘Productive Power’ is the power that is transferred from electrical energy to some other form of energy (i.e. such as heat energy or mechanical energy). The apparent power is always in excess of the productive power for inductive loads and is dependent on the type of machine in use. The working power (KW) and reactive power (KVAR) together make up apparent power, which is measured in kilovolt-amperes (KVA). Graphically it can be represented as:



Any industrial process using inductive loads such as electric motors (to drive pumps, fans, conveyors, and refrigeration plant etc.) introduces inefficiencies into the electricity supply network by drawing additional currents, called "inductive reactive currents". Although these currents produce no useful power, they increase the load on the distribution network and cabling. The inefficiency is expressed as the ratio of useful power to total power (kW/kVA), known as Power Factor.

Typical uncorrected industrial power factor is 0.8. This means that a 1MVA transformer can only supply 800 kW or that a consumer can only draw 80 useful Amps from a 100 Ampere supply. To put it the other way, a 3-phase 100 kW load would draw 172 Ampere per phase instead of the 139 Ampere expected. For inherently low power factor equipment, the utility company has to generate much more current than is theoretically required. This excess current flows through generators, cables, and transformers in the same manner as the useful current. If steps are not taken to improve the power factor of the load, all the equipment from the power station to the installation sub-circuit wiring, has to be larger than necessary. This results in increased capital expenditure and higher transmission and distribution losses throughout the whole network.

To discourage these inefficiencies the electricity companies charge for this wasted power. These charges appear on electricity bills as "reactive power charges" and/or "KVA maximum demand". For example, information taken from billing about electrical system:

Case - 1: Active power drawn - 800 and billing power factor - 0.80

Billing Structure - The billing demand will be 1000 kVA at billing power factor 0.80, therefore unit have to pay demand charges for 1000 kVA.

Case - 2: Active power drawn - 800 and billing power factor - 1 (unity)

Billing Structure - The billing demand will be 800 kVA at billing power factor 1.0, therefore unit have to pay demand charges for 800 kVA.

The reactive power charges levied as penalties in the billing should always be regulated. The excess reactive currents and associated charges can be removed by a well-established technology called "Power factor correction". Simply put, this technology offsets the inductive reactive currents by introducing equal and opposite capacitive reactive currents. Typically this can reduce electricity bills by 3-5%, with a payback period of 12 to 18 months. In addition, the consumer shall gain from improved supply availability, improve voltage and reduced power losses.

To avoid the penalty in the utility bill, reduce the losses in electricity and power quality, it is always recommended to maintain the power factor close to unity at MCC & PCC level. Power factor correction can be made in two ways:

- Reduce the amount of reactive energy
 - ✓ Eliminate unloaded motors and transformers
 - ✓ Avoid supplying equipment with voltage in excess of the rated voltage
- Compensate artificially for the consumption of reactive energy with power factor capacitors. In practice, two type of equipment are available for power factor correction:
 - ✓ Rotary Equipment: Phase advancers, synchronous motors and synchronous condensers. Where auto-synchronous motors are employed the power factor correction may be a secondary function.
 - ✓ Capacitors: Power factor correction is achieved by the addition of capacitors in parallel with the connected motor circuits and can be applied at the starter, or applied at the switchboard or distribution panel. Capacitors connected at each starter and controlled by each starter is known as "Static Power Factor Correction" while capacitors connected at a distribution board and controlled independently from the individual starters is known as "Bulk Correction".

Addition of the capacitor to improve the line power factor is most common method adopted in industrial sector. The power factor can be corrected by

- Static or fixed Power Factor correction

Compensation on the load side of the AC motor starter (motor switched or "at the load"). Fixed capacitors provide a constant amount of reactive power to an electrical system. Primarily, fixed

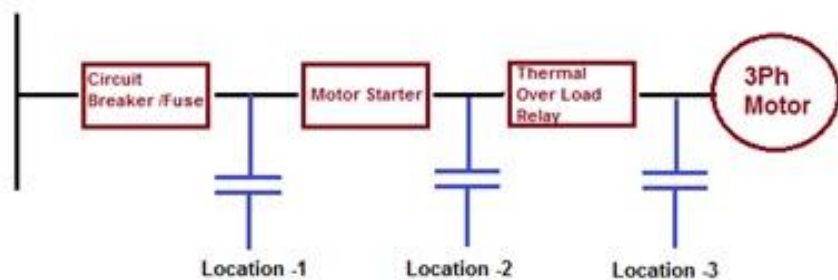

capacitors are applied to individual motor loads, but they can also be applied to the main power bus with proper treatment. Fixed capacitors are suitable for indoor or outdoor use. Fixed capacitors are available in low voltages (832 volt and below), from 0.5 KVAR up to 400 KVAR (If more than 400 KVAR is required, smaller units are paralleled together).

- Central or Bulk Power Factor correction

Central power factor compensation is applied for electrical systems with fluctuating loads. The central power factor correction is usually installed at the main power distribution. The capacitors are controlled by a microprocessor-based relay, which continuously monitors the power factor of the total current supplied to the distribution board. The relay then connects or disconnects capacitors to supply capacitance as needed in a fashion to maintain a power factor better than a preset limit (typically 0.95). Ideally, the power factor should be as close to unity as possible.



To select the amount of kVAR required to correct the lagging power factor of a 3- phase motor, following are the recommended steps.

- Step #1: Determine KW and Existing Power Factor.
- Step # 2: Existing Power Factor on Table, move across table to Desired Power Factor. The number represented is your multiplier number.
- Step #3: Multiply KW by the multiplier of the Desired Power Factor.

Similarly, the power factor improvement at load end (electric motor) can be determine using the table given blow

Motor Rating (HP)	Capacitor rating (kVAr) for Motor Speed					
	3000	1500	1000	750	600	500
5	2	2	2	3	3	3
7.5	2	2	3	3	4	4
10	3	3	4	5	5	6
15	3	4	5	7	7	7
20	5	6	7	8	9	10
25	6	7	8	9	9	12
30	7	8	9	10	10	15
40	9	10	12	15	16	20
50	10	12	15	18	20	22
60	12	14	15	20	22	25
75	15	16	20	22	25	30
100	20	22	25	26	32	35
125	25	26	30	32	35	40
150	30	32	35	40	45	50
200	40	45	45	50	55	60
250	45	50	50	60	65	70

Some checks that need to be adopted in use of capacitors are:

- Nameplates can be misleading with respect to ratings. It is good to check by charging currents.
- Capacitor boxes may contain only insulated compound and insulated terminals with no capacitor elements inside.
- Capacitors for single phase motor starting and those used for lighting circuits for voltage boost, are not power factor capacitor units and these cannot withstand power system conditions.

2.1.3 Adoption of renewable energy

Rooftop solar system

Solar Power, a clean renewable resource with zero emission, has got tremendous potential of energy which can be harnessed using a variety of devices. With recent developments, solar energy systems are easily available for industrial use with the added advantage of minimum maintenance. The average solar irradiation in Gujarat state is 5.82 kWh/m²/day and Uttar Pradesh is 4.27 kWh/m²/day.

A grid connected photovoltaic system will be interacted with utility grid. The main advantage of this system is that power can be drawn from the utility grid and when power is not available from grid, PV system can supplement that power. These grid connected systems are designed with battery or without battery storage. These systems consist of the following:

- Solar panels mounted on the roof or in open spaces. Photovoltaic modules produce direct current (DC) electrical power.
- Batteries to store DC energy generated by the solar panels.
- Charge controller to prevent overcharging the battery.
- Specially designed inverter to transform the PV generated DC electricity to the grid electricity (which is of AC) at the grid voltage.

2.2 Government Schemes and Policy

2.2.1 Credit Linked Capital Subsidy Scheme (CLCSS)

The objective of the Scheme is to facilitate technology up-gradation in MSEs by providing an upfront capital subsidy of 15 per cent (on institutional finance of upto Rs 1 crore availed by them) for induction of well-established and improved technology in the specified 51 subsectors/ products approved. In other words the major objective is to upgrade their plant & machinery with state-of-the-art technology, with or without expansion and also for new MSMEs which have set up their facilities with appropriate eligible and proven technology duly approved under scheme guidelines. List of Technologies is available at www.dcmsme.gov.in

(Source: http://www.dcmsme.gov.in/schemes/credit_link_scheme.htm)

2.2.2 Credit Guarantee Fund Trust for MSE

This scheme will cover both term loan and working capital facility upto Rs.100 lacs. Under this scheme, loan will be sanctioned without any collateral security or third party guarantee. For more details of the scheme visit www.cgtmse.in

(Source: <https://www.cgtmse.in>)

2.2.3 Technology Up-gradation Scheme for Micro Small and Medium Enterprises (MSMEs)

The first objective of the scheme is to sensitize and encourage the manufacturing MSME sector in India to the use of Energy Efficient Technologies and Manufacturing Processes so as to reduce cost of production and emissions of GHGs.

The second objective of the scheme is to create awareness and encourage the MSMEs to acquire Product Certification/ Licenses from National/ International Bodies.

(Source: <http://www.dcmsme.gov.in/schemes/TEQUPDetail.htm>)

2.2.4 Assistance for Saving in Consumption of Energy & Water (Gujarat state)

- The existing as well as new enterprise taking action for saving in consumption of Energy and Water will be eligible for assistance under this scheme
- The Enterprises which are registered as an industrial unit under MSME Development act, 2006 with respective DIC are eligible to get benefit
- 75% cost of energy/water audit conducted in a unit by a recognized institution/consultant subject to a limit of Rs. 50,000.
- 25% of cost of equipment subject to maximum Rs. 20 lakhs per project. Only one time assistance will be eligible during the operative period of the scheme

(Source: <https://ic.gujarat.gov.in/assistance-for-saving-in-consumption-of-energy.aspx>)

3.0 Module 2 – Energy efficient and Renewable Energy (EE/ RE) Technologies & BoPs

3.1 Best operating practices (BoPs)

The “best operating practices” (BOPs) is framed with an objective to support in optimizing operating parameters and specific energy consumption close to the design level. Critical and energy consuming equipment/ system/ process are considered under this section. It provides a summary of applicable BOPs which can be followed by ceramic industries.

The purpose of this guide is also to provide the Operations and Maintenance (O&M)/ plant maintenance team and energy practitioner, with useful information about O&M management, technologies, energy efficiency and cost-reduction approaches.



The guiding principle of “Preventive” and “Predictive” maintenance is the regular and systematic application of engineering knowledge and maintenance attention to equipment and facilities to ensure proper functionality, optimize the performance and reduce the rate of deterioration. It encompasses regular examination, inspection, lubrication, testing and adjustments of equipment without prior knowledge of equipment failure. These maintenance practices also provide framework for all planned maintenance activity, including the generation of planned work orders to correct potential problems identified during the inspections. Adoption of these practices in a ceramic industry would lead to a proactive environment, optimizing equipment performance and life.

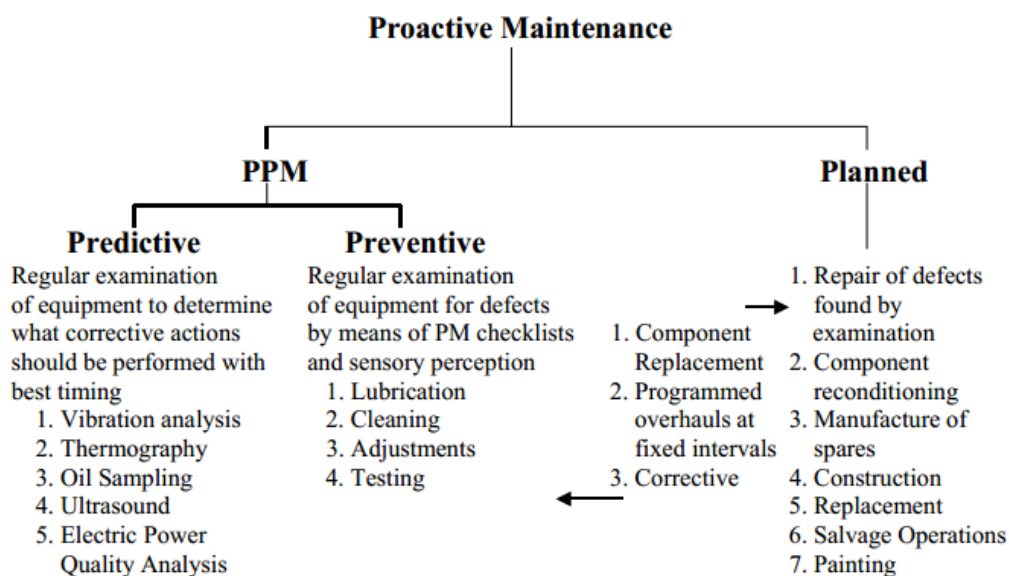

(Source: TERI 2017)

A total proactive maintenance program is essential for efficient, reliable and safe production process. Benefits are direct and substantial, includes the high product quality, long machine life, avoidance of work stoppage and high safety. The essential requirements for proactive maintenance practices are:

- Commitment and leadership
- Compliance and discipline
- Process level intervention to perform regular maintenance checks
- Best operational practices must be instituted to enable the facility to achieve an efficient production system to deliver quality and on time product.

3.1.1 Kiln

Kilns are important segment in ceramic industries and accounting for about 50-65% of energy consumption. Various operating parameters such as temperatures, draft, retention time and material arrangement, etc. may vary with the type of kilns used. Best operating practices are employed to reduce SEC level of a kiln. The operating parameters of kiln along with associated auxiliaries must be maintained appropriately close to design/standard values. BOPs have significant influence on energy use and changes in operating practices within the limitations of kiln design and associated equipment may help in reducing specific energy consumption.

Monitoring of operating parameters and periodic maintenance are essential elements for achieving optimum performance and energy use. It is significant to monitor the performance of kiln parameters in order to identify the need for careful attention for maintenance which can help to sustain efficient use of energy. In addition to regular maintenance and fine-tuning/ calibration of associated control system, it is also recommended to undertake rigorous monitoring of kiln on a regular basis. The plant may prepare schedule for examining the set points and calibration of the kiln control system as well as the auxiliaries. The recommended period for the calibration is generally 6-12 months depending on the sensitivity of the system/sensors used and the level of the periodic maintenance schedule adopted. Such type of practices would help operator/supervisor to analyze the specific energy use and also indicate the deteriorations or improvements in performance. This section provides the O&M practices essential to be followed and BOPs that are applicable for different types of kiln.

Air-to-fuel ratio

A ratio control technique/practice can play an important role in optimum and profitable operation of kiln and similar processes. The air-to-fuel ratio in the combustion zone directly impacts fuel combustion efficiency and emissions. A requirement for ratio control technique implementation is that both the fuel supply rate and combustion air flow rate are measured and available as process variable indicators. A typical air to fuel ratio control system is shown below.

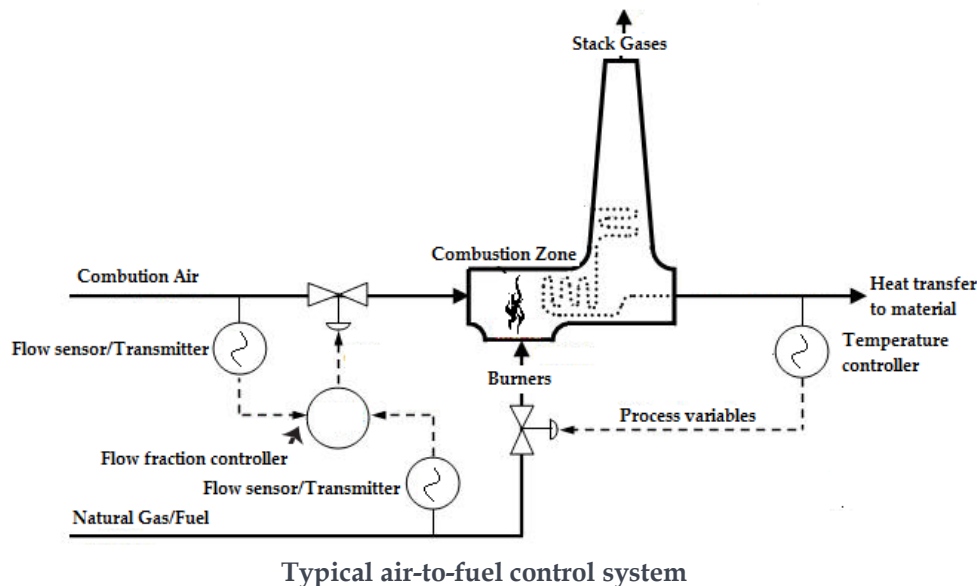

(Source: TERI 2017)

In the combustion process, air-to-fuel ratio is generally expressed on a mass basis. The maximum useful heat energy is derived by supplying combustion air (stoichiometric or theoretical) that properly matches with the flow rate of fuel to the burner. The fuel flow rate is adjusted to maintain temperatures in different furnace zones. The combustion air flow rate is simultaneously adjusted by a flow fraction controller to maintain the optimum air-to-fuel ratio. The chemical equation for the combustion of fuel is shown below:

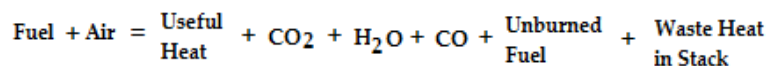

CO₂ - Carbon dioxide
 CO - Carbon monoxide
 H₂O - Water

Air is mainly composed of oxygen (O₂) and nitrogen. Oxygen combines with carbon in the fuel in a highly energetic reaction called combustion and forms which carbon dioxide (CO₂), which is the common greenhouse gas (GHG) produced from the complete combustion of hydrocarbon fuel. Water vapour is also a normal product of hydrocarbon combustion.

The relationship between the air-to-fuel ratio and wasted heat energy provides a basis for control system design. In most of the cases, real combustion processes have inadequate mixing of air with fuel. Also, the gases tend to flow so quickly that the air and fuel mix have limited contact time in the combustion zone. As such, if air is fed in exact theoretical or stoichiometric proportion to the fuel, it will still lead to incomplete combustion. Automatic burner assembly generally performs in a manner similar to the graph. The cost associated with operating at increased air-to-fuel ratio is the energy wasted in heating additional air volume. Yet, if the air-to-fuel ratio is decreased, losses due to incomplete combustion and emission will increase rapidly.

Too Little Air Increases Pollution and Wastes Fuel	Too Much Air Wastes Fuel
<p>↳ If the air-to-fuel ratio is too small, there will not be enough oxygen available to completely convert the hydrocarbon fuel to carbon dioxide and water. Too small air-to-fuel ratio leads to incomplete combustion of fuel. As the availability of oxygen decreases, noxious exhaust gases including carbon monoxide will be formed first. As the air-to-fuel ratio decreases further, partially burned and unburned fuel may appear in the exhaust stack, often revealing itself as smoke and soot.</p>	<p>↳ The issue that makes operation of a combustion process so interesting is that if feed air to the combustion zone is high (if the air-to-fuel ratio is too high), waste of fuel, though in a wholly different manner. Once enough oxygen available in the burn zone to complete combustion of fuel, it would have addressed the pollution portion of combustion chemistry equation. However, any air fed to the process above and beyond that amount becomes an additional process load to be heated.</p>
<p>↳ Incomplete combustion also means wasting expensive fuel. Fuel that does not burn to provide useful heat energy, including carbon monoxide that could yield energy as it converts to carbon dioxide, literally flows up to exhaust stack as lost profit.</p>	<p>↳ As the air-to-fuel ratio increases above that needed for complete combustion, the extra nitrogen and unneeded oxygen absorb heat energy, decreasing the temperature of flame and gases in combustion zone. As the operating temperature drops, less extraction of useful heat energy for intended applications.</p>

Optimum capacity utilization

The capacity utilization (commonly known as “loading”) of a kiln is one of the key factors affecting the efficiency. The loading of a kiln includes preparation of material to feed, amount of material placed, arrangement inside the kiln and the residence time inside the kiln.

Optimum arrangement of load

The feedstock on the hearth should be arranged in such a manner that:

- ✓ It receives maximum amount of radiation from the hot surfaces of the heating chambers and flames
- ✓ Hot gases are efficiently circulated around the heat receiving surfaces of the materials

Stock should not be placed in the following positions:

- ☒ In the direct path of the burners or where impingement flame is likely to occur
- ☒ In an area that is likely to cause a blockage or restriction of the flue system of the kiln
- ☒ Close to any door openings where cold spots are likely to develop

Check list

- ↪ Check the concentration of oxygen in flue gases, which is an indication for excess air level for combustion of fuels. If the level is high, check for air infiltration
- ↪ Check the level carbon monoxide in flue gases which indicates combustion efficiency or the un-burnt that affect thermal efficiency of furnace
- ↪ The air to fuel ratios at high and low firing conditions
- ↪ The burners are not over-rated and should be able to operate at low fire condition throughout the production campaign
- ↪ There is adequate mixing of air and fuel at the burner
- ↪ Check pre-heated air temperature which indicates the condition of recuperator and cleaning requirements.

Raw Material Processing

- ✓ Purchase the right materials, it will save the energy and costs that would otherwise have to be incurred to treat them in the unit
- ✓ Raw material is transported to the processing areas by conveyers: do not let the conveyor ON when there is no material to be transported.
- ✓ Fit timer switches on all the grinding machines so that they automatically switch
- ✓ off after processing of the raw material

Ball mill

- ✓ Always operate the ball mill at its critical loading point. The material loading of the ball mill is a critical parameter in determining the energy consumption. Specific Energy Consumption will increase if the ball mill is loaded below/above the critical loading point.
- ✓ Irrespective to the size of ball mill, ceramic lined mill, pebble mill, jar mill or laboratory jar rolling mill, its rotational speed is important to proper and efficient mill operation.
 - Too low a speed and little energy is imparted on the product. Too fast and inefficient media movement will generate high impact but also greatly increase mill wear.
 - Even faster speed will result in the media centrifuging inside the mill and virtually no milling or movement of media or product will occur. In most cases, the ideal mill speed will have the media tumbling from the top of the pile (the shoulder) to the bottom (the toe) with many impacts along the way.
 - The ideal mill speed is usually somewhere between 55% to 75% of critical speed.

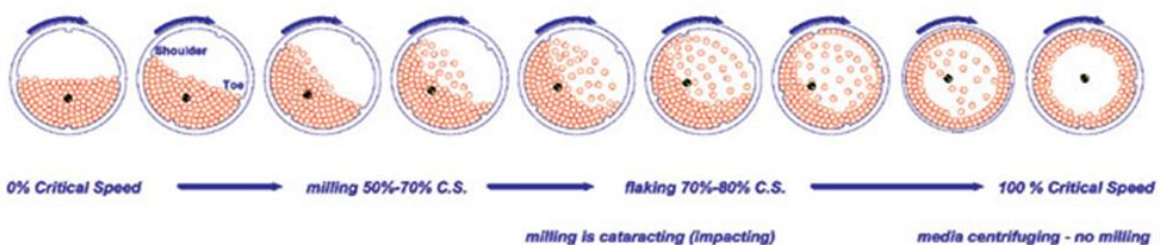

- ✓ Use grinding media (pebbles) in three different sizes for better and efficient grinding of raw material.
- ✓ Check the mesh size of the slurry - when it reaches the required value, switch off ball mill/blunger.
- ✓ Regularly monitor batch time.
- ☒ Don't blend the clay two or three days in advance.

3.1.2 Utilities

Compressed air system and distribution network

The delivery pressure of compressors is generally 1.1 kg/cm² (100 kPa) or higher. Compressed air systems are usually designed to operate within a fixed pressure range and to deliver a volume of air that varies with system demand.

Quality	Applications
Plant Air	Air tools, general plant air
Instrument Air	Laboratories, paint spraying, powder coating, climate control
Process Air	Food, pharmaceutical, electronics etc.

Compressed air needs are defined by air quality, quantity and pressure level required by the end use points. Analyzing needs carefully will ensure that a compressed air system is configured properly.

Air quality: The quality of compressed air is determined by dryness and contaminant level permissible at end use and need is to be accomplished using drying and filtering equipment. Higher the quality more cost to produce air. Typical air quality for various industrial applications is shown in table. High quality air usually requires additional equipment, which not only increases initial capital investment, but also makes the overall system more expensive to operate in terms of energy consumption and maintenance costs.

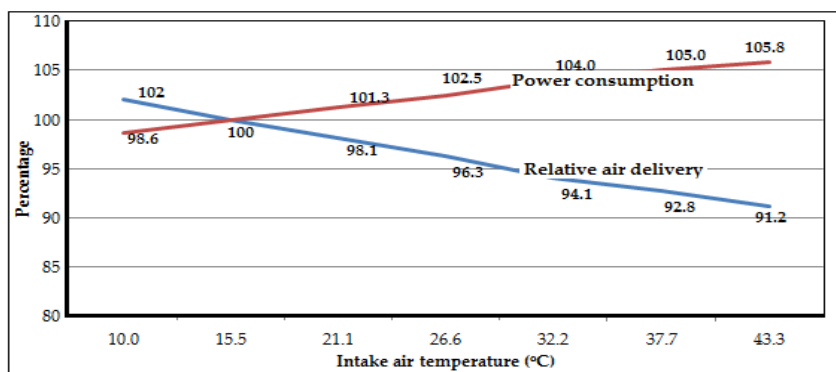

Effect of intake air temperature on performance

High quality air usually requires additional equipment, which not only increases initial capital investment, but also makes the overall system more expensive to operate in terms of energy consumption and maintenance costs.

Intake air: The air entering compressor should be as cool as possible to maintain the specific power consumption at design because cold air is denser than warm air. The colder the incoming air, the more the air molecules there are, so that more air is compressed for each revolution of the air

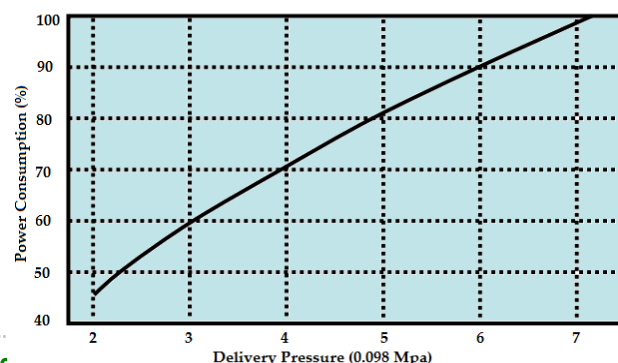

Power consumption vs delivery pressure

compressor. Also the cooler the incoming air, the lesser the requirements for intercooling and after cooling. The compressor room should also be cleaner and cooler for optimum compressor operation.

For about 4 °C rise in intake air temperature, the power consumption increases by about 1% for the same air delivery.

Generation pressure: System pressure is monitored and control system decreases the compressor output when the pressure reaches a pre-set level. Compressor output is increased again when the pressure drops to a lower value than the pre-set. The difference between these two pressure levels is called the control range. Depending on pressure requirement at utilization end, the control range can be anywhere from 0.15-1.5 kg/cm². To optimize the generation cost of the compressed air selection of appropriate capacity and reduction in delivery pressure are two critical parameters. (Source: TERI 2017)

A rule of thumb for systems in the 7.0 kg/cm² range is for every 0.15 kg/cm² increase in discharge pressure, energy consumption will increase by approximately 1 per cent at full output flow.

Raising the compressor discharge pressure increases the demand of every unregulated usage, including leaks, open blowing, etc. Although it varies from plant to plant, unregulated usage is commonly as high as 30-50% of air demand.

Prevention of leakages: Compressed air system leak repair program is very important to maintaining the efficiency, reliability, stability and cost effectiveness of compressed air system. One of the best practices to avoid the losses due to leakages in compressed air distribution network is leak prevention activities. There are two basic types of leak repair activities, the “leak tag” and “seek and repair”. The “seek and repair” is the simplest method which allows the team to find the leaks and repair them immediately. The “leak tag” involves the tagging the identified and logging for repair at a later time. Both the activities may be undertaken during the preventive maintenance practices and/or the plant may regularly conduct the leakage test to identify the activities to be performed to repair the leak.

O&M Practices and schedule: Most of the ceramic industries in the country use lubricant-injected rotary compressor. The general O&M practices and the schedule to perform the practices in lubricant-injected rotary compressor are given in table.

Period	Activities
Periodically/Daily (8 Hours Maximum)	<ul style="list-style-type: none"> ▪ Monitor all gauges and indicators for normal operation ▪ Check lubricant level and top off as necessary ▪ Check for lubricant leaks ▪ Check for unusual noise or vibration ▪ Drain water from air/ lubricant reservoir ▪ Drain control line filter.
Weekly	<ul style="list-style-type: none"> ▪ Check safety valve operation

Period	Activities
Monthly	<ul style="list-style-type: none"> ▪ Service air filter as needed ▪ Wipe down entire unit to maintain appearance ▪ Check drive motor current at full capacity and design pressure ▪ Check operation of all controls ▪ Check operation of lubricant scavenger/return system and clean as necessary.
Half-yearly or every 1,000 Hours	<ul style="list-style-type: none"> ▪ Take lubricant sample ▪ Change lubricant filter. Manufacturers may recommend changing the lubricant filter within the first week of operation to rid the system of foreign particles which may have been collected during initial assembly and start-up.
Annually/ Periodically	<ul style="list-style-type: none"> ▪ Go over unit and check all bolts for tightness ▪ Change air/lubricant separator ▪ Change air filter ▪ Lubricate motors per manufacturer's instructions ▪ Check safety shutdown system. Contact authorized serviceperson.

3.1.3 Motor maintenance

Electric motors fail for a variety of reasons. Certain components of motors degrade with time and operating stress. Electrical insulation weakens over time with exposure to voltage unbalance, over and under-voltage, voltage disturbances, and temperature. Contacts between moving surfaces cause wear. Wear is affected by dirt, moisture, and corrosive fumes and is greatly accelerated when lubricant is misapplied, becomes overheated or contaminated, or is not replaced at regular intervals. When any components are degraded beyond the point of economical repair, the motor's economic life is ended. An electric motor performs efficiently only when it is maintained and used properly. Electric motor efficiencies vary with motor load; the efficiency of constant speed motor decreases as motor load decreases. Below are some general guidelines for efficient operations of electric motors.

Turn off unneeded motors: Locate motors that operate needlessly, even for a portion of the time they are on and turn them off. For example, there may be multiple HVAC circulation pumps operating when demand falls, cooling tower fans operating when target temperatures are met, ceiling fans on in unoccupied spaces, exhaust fans operating after ventilation needs are met.

Sizing motors: It is necessary to assess the actual loading of existing motors especially when replacing motors. Many motors operate most efficiently in the range of 75-85% of full load rating. Under-sizing or over-sizing will lead to operate at reduced efficiency.

Replacement of motors versus rewinding: Instead of rewinding small motors, consider replacement with an energy efficient version. For larger motors, if motor rewinding offers the lowest life-cycle cost, select a rewind facility with high quality standards to ensure that motor efficiency is not adversely affected.

Preventive and predictive maintenance: These maintenance procedures involve a sequence of steps to be used to prolong motor life or foresee a motor failure. Predictive maintenance programs for motors observe the temperatures, vibrations and other data to determine a time for overhaul or replacement of the motor. Preventive maintenance takes steps to improve motor performance and to extend its life. Common preventive tasks include routine lubrication, allowing adequate ventilation and ensuring the motor is not undergoing any type of unbalanced voltage situation etc.

Most motor cores are manufactured from silicon steel or de-carbonized cold-rolled steel, the electrical properties of which do not change measurably with age. However, poor maintenance can cause deterioration in motor efficiency over time and lead to unreliable operation. The general O&M practices and the schedule to perform the practices in electric motor is given in table.

Period	Activities
Periodically/Change in duty cycle	<ul style="list-style-type: none"> ▪ Turn off/sequence unnecessary motors ▪ Complete overall visual inspection to be sure all equipment is operating and safety systems are in place ▪ Check load conditions to avoid the over or under loading conditions due to change in duty cycle or associated load profile ▪ Check for alignment of the motor and the driven equipment. Improper alignment can cause shafts and bearings to wear quickly, resulting in damage to both the motor and the driven equipment
Weekly	<ul style="list-style-type: none"> ▪ Check condition of motor through temperature or vibration analysis and compare to baseline values
Monthly	<ul style="list-style-type: none"> ▪ Assure that all bearings are lubricated per the manufacture’s recommendation ▪ Check packing for wear and repack as necessary. Consider replacing packing with mechanical seals. ▪ Aligning motor coupling allows for efficient torque transfer to pump ▪ Check and secure all motor mountings ▪ Tighten connection terminals as necessary ▪ Remove dust and dirt from motor to facilitate cooling
Annually Periodically	<ul style="list-style-type: none"> ▪ Ensure that supply wiring and terminal box are properly sized and installed ▪ Inspect regularly the connections at the motor and starter to be sure that they are clean and tight ▪ The life of the insulation in motor would also be longer; for every 10°C increase in motor operating temperature over the recommended peak, the time before rewinding would be needed is estimated to be halved. ▪ Over- or under-voltage situations can shorten the motor life through excessive heat build up

3.1.4 Illumination system

Illumination system is one of the areas which do not have significant share of energy consumption in ceramic industries. However, adoption of best practices is required to maintain the better work environment and other safety aspects. Following are the key operation and maintenance practices necessary for efficient and preferred lux level as per task.

- Use of appropriate selection of lamps and luminaire from the time of the designing and commissioning.
- Establish schedules for re-lamping, cleaning, recalibration and revaluation of the lighting system.
- The ballasts and lighting controls must be specified for factory pre-set to the extent possible.
- Some lighting equipment is designed to task specific which may be sensitive to orientation such as spotlight, wall washers and occupancy sensors. A “pre-application diagram” can be specified or requested prior to installation.

Some maintenance items such as swirling lamps or inoperable ballasts obviously require immediate attention and repair. To maintain the desired properties of the illumination system, following are the key O&M practices to be adopted.

Period	Activities
Need based/One-time analysis	<ul style="list-style-type: none"> ▪ Identify areas where day lighting controls could be used ▪ Identify areas where local automatic controls could be used
Monthly	<ul style="list-style-type: none"> ▪ Inspect fixtures to identify inoperable or faulty lamps or ballasts. Burned out lamps may damage ballasts if not replaced.
Half yearly	<ul style="list-style-type: none"> ▪ Inspect fixtures and controls to identify excessive dirt, degraded lenses, inoperable or ineffective controls ▪ Measure light levels compared to tasks needs in typical spaces. Identify areas for reduction or increase in luminance
Annually/ Periodically	<ul style="list-style-type: none"> ▪ Lamps and fixture reflective surfaces should be cleaned periodically for maximum efficient delivery of light to the space ▪ Clean surfaces allow maximum distribution of light within the space ▪ For larger facilities consider group re-lamping

4.0 Module 3 – Kiln (Burner, automation and waste heat recovery)

4.1 Drying Process and Equipment

In the process of ceramic manufacturing, the major energy is drawn into the drying process and its associated auxiliaries. The thermal energy used in the drying process is primarily from natural gas. Other than the thermal energy, electricity is also used in driving the associated auxiliaries such as fans, blowers and material handling systems. In a ceramic manufacturing process, the thermal energy share is about 60-70%, whereas the electrical share is about 30-40%. Thus, it is very essential to adopt automation and new and energy efficient technologies/practices to optimise the cost of operation as well as minimising the emissions.

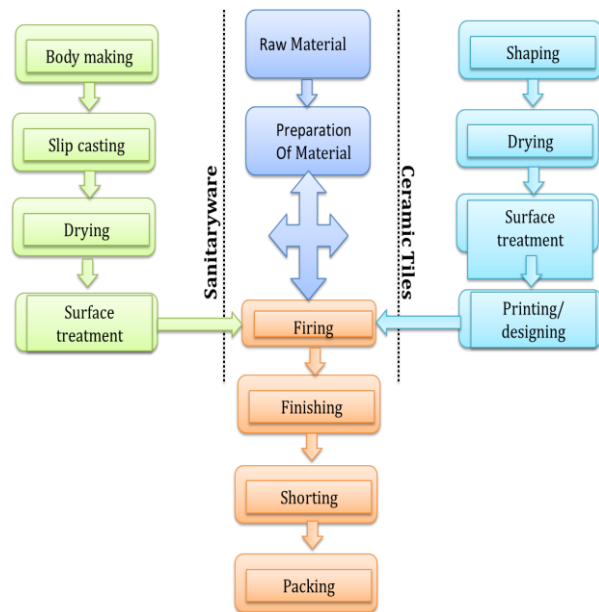

In the ceramic clusters, mainly tunnel kiln and roller kiln are employed. In sanitaryware manufacturing, pusher type tunnel kilns are most common and in tiles manufacturing, roller kilns are installed.

4.1.1 Types of kilns

Tunnel kiln

Tunnel kiln is a continuous moving ware kiln in which the clay products to be fired are passed on cars through a long horizontal tunnel. The firing of products occurs at the central part of the kiln. The tunnel kiln is considered to be the most advanced ceramic and brick products making technology. The main advantages of tunnel kiln technology lay its ability to fire a wide variety of clay products, better control over the firing process and high quality of the products.

The tunnel kiln is, as the name shows, a narrow and long tunnel having the rails in both sides at the bottom. The wares loaded on the kiln cars are charged through the entrance of the tunnel and route continuously through the pre-heating, firing and cooling zones, and then discharged from the exit as shown in figure

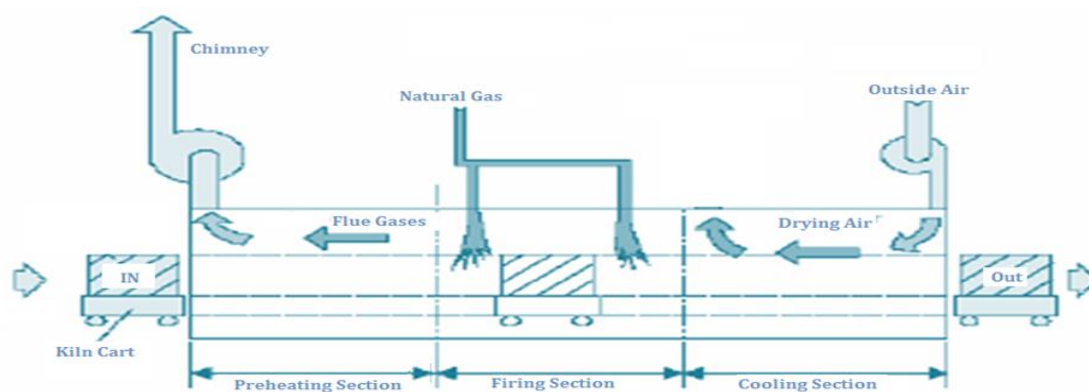

The combustion gas and air always flow from the kiln exit to the entrance such that the adjustment of one firebox affects not only the firing zone but also the pre-heating zone. Especially at reducing firing, the adjustment requires the most care and experience considering various factors; the border of oxidizing and reducing zones and that of reducing and neutral zones, the effect of cooling air to firing zone, the relation between the temperature and atmosphere in reducing zones, etc.

In such type of kilns heavy refractory carts and saggars are generally carry ceramic products through the different temperature zones of the kiln. These carts are generally heavy carts made up of refractory materials which do not take part in any reactions in formation of ceramic products, are subjected to alternate heating and cooling cycles. The general specifications of tunnel kiln commonly used in sanitary ware manufacturing process are given in table below.

Parameters	Units	Type - 1	Type - 2	Type - 3
Internal kiln width	m	2.62	3.04	3.45
Useful car width	m	2.42	2.83	3.23
Car length	m	1.4	1.4	1.4
Useful car length	m	1.38	1.38	1.38
Useful loading height	m	0.8-1.1	0.8-1.1	0.8-1.1
Useful car area	m ²	3.35	3.92	4.48
Kiln length	m	45-90	45-100	60-110
Maximum temperature	oC	1350	1350	1350
Indicative firing cycle	Hours	10-14	10-14	10-14
Indicative specific consumption	Kcal/kg	1100-1300	1100-1300	1100-1300

Roller kiln

In such type of kiln the product movement is governed through silicon carbide based roller. It is a continuous kiln where in the product flow is continuous though different temperature zones. Controlling of is mostly though temperate based controlled installed in different temperature zones.

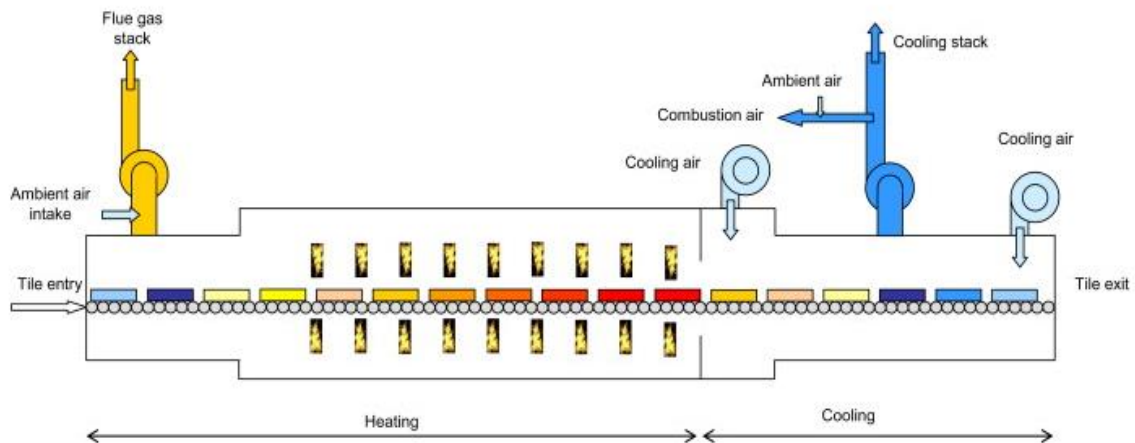

In ceramic tiles manufacturing process, there are different types of kilns but the most appropriate and the most efficient kiln is the roller kiln. This type of kiln is continuous firing kiln with ceramic rollers which transport ceramic tiles at different firing temperature with uniform temperature distribution. Usually the temperature in the inlet does not vary significantly with the outlet of the preheating zone and the temperature is usually highest at its 3rd quarter's section. The temperature of the kiln outlet is also control to prevent thermal shock which may result to breakage of resulting tiles.

Table 4.1.1: Basic kiln details

Parameters	Units	Type 1	Type 2
Maximum temperature	°C	1250	1250
Channel width	m	2.6	2.85
Optimum load width	m	2.36	2.6
Indicative length	m	65-180	75-200

4.1.2 Heat balance of kiln

Heat balance of the kiln is a mean to determine the thermal efficiency of the system and compare the relative heat losses. By making comparison with an identical process, areas of inefficiency can be identified, where a change in operational control or equipment could lead to improvement in thermal efficiency of the kiln.

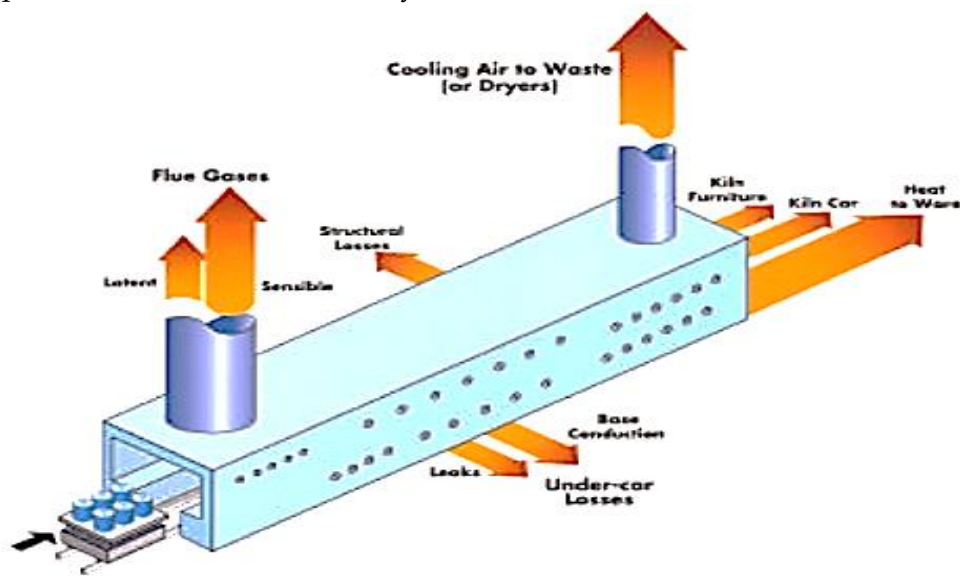

It may be observed that about 50% of the energy is lost through the kiln combustion flue gas and cooling gas stacks. In the present scenario the residual heat of the gases from the cooling stack is mainly reused. Since these gases consist of air without pollutants result from the direct contact of the air used to reduce the tile temperature in the cooling zone. Other losses like radiation, losses due to composition of fuel accounts for about (10 to 30%). The heat losses clearly indicate significant potential to reduce the consumption of energy resources as well as scope to improve the competitiveness of the ceramic sector.

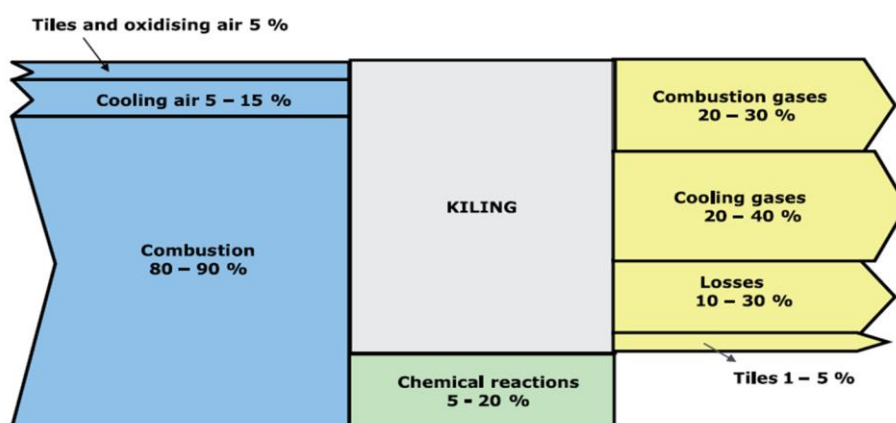

4.1.3 Energy conservation and technology options

This section provides detailed assessment of appropriate energy efficient (EE) technologies that would lead to improvement in the performance of kiln and its associated equipment. In the ceramic manufacturing process, kiln account for about 60-70% of the total primary energy consumption in the form of thermal energy. Hence it is one of the focus areas for application of new and efficient technologies. The efficiency of the kiln depends not only on its design parameters but also on operation and requirements for uniform heating.

The basic concepts of energy conservation in kiln include optimization of combustion, rationalization of heating and cooling, minimization of structural heat losses and recovery of waste heat in flue gases.

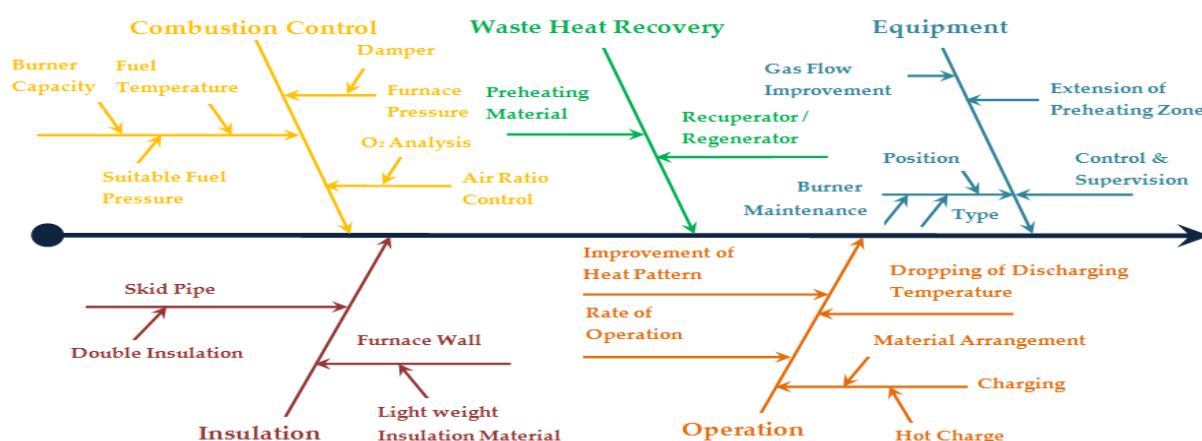

Characteristic diagram of energy optimization, maintenance practices and control system in kiln



The following section provides an overview of technologies that can play a vital role to optimize energy consumption, temperature profile and other operational aspects to improve the quality of the end product.

4.1.4 Energy conservation of thermal energy

Considering the fuel reserves and increasing competition, it is essential to adopt energy conservation measures to improve overall efficiency, reduce operating cost/production cost and minimise the load on energy resources. The efficiency of a kiln will depend on how efficient the combustion system is and secondly how best the generated heat is utilized. Use of standard and good quality fuel improves overall performance of the firing system. Around 5 - 15% energy saving is possible from kilns used in ceramic industries. Some of the potential energy conservation measures (ECMs) for thermal system are listed below.

- Optimum kiln design to ensure capacity utilization to the tune of 98%
- Use of optimum product thickness to reduce heat load for sintering
- Complete combustion with minimum excess air.
- Proper heat distribution.
- Operating the kiln at desired temperature.
- Reducing heat losses from the openings.
- Minimizing wall losses by improving kiln insulation.
- Waste heat recovery from fuel gasses and utilization for drying green products
- Control of Chimney draught and kiln pressure
- Use pre-heating of spray dryer input slurry either solar or electrical heat pump
- Biomass / briquette firing in hot air generation
- Fuel switch over with better option in spray dryer
- Switching to continuous type kilns from intermittent type
- Adopting best operating practices including optimizing of excess air levels
- Use of hot air from cooling zone to preheat input material
- Energy efficient burner that can handle pre-heated combustion air at higher temperature
- Arresting air infiltration in kilns and spray drier system
- Use of lubricants and proper maintenance

Application of ECMs and absolute energy saving would largely depend on the base case scenario and relevant parameters likes operating efficiency of equipment, operating hour, operating load, landing fuel price etc. Some of the applications of ECMs are described below.

Air to fuel ratio control in combustion system

Kilns are important segment in ceramic industries and accounting for about 50-65% of energy consumption. Various operating parameters such as temperatures, draft, retention time and material arrangement, etc. may vary with the type of kilns used. Best operating practices are employed to reduce SEC level of a kiln. The operating parameters of kiln along with associated auxiliaries must be maintained appropriately close to design/standard

values. BOPs have significant influence on energy use and changes in operating practices within the limitations of kiln design and associated equipment may help in reducing specific energy consumption.

Monitoring of operating parameters and periodic maintenance are essential elements for achieving optimum performance and energy use. It is significant to monitor the performance of kiln parameters in order to identify the need for careful attention for maintenance which can help to sustain efficient use of energy. In addition to regular maintenance and fine-tuning/ calibration of associated control system, it is also recommended to undertake rigorous monitoring of kiln on a regular basis. The plant may prepare schedule for examining the set points and calibration of the kiln control system as well as the auxiliaries. The recommended period for the calibration is generally 6-12 months depending on the sensitivity of the system/sensors used and the level of the periodic maintenance schedule adopted. Such type of practices would help operator/supervisor to analyze the specific energy use and also indicate the deteriorations or improvements in performance. This section provides the O&M practices essential to be followed and BOPs that are applicable for different types of kiln.

More the air is used to burn the fuel, more is the heat wasted in heating air. Air, slightly in excess of ideal stoichiometric (or theoretical) fuel to air ratio is required for complete combustion and to reduce NO_x emissions; it is dependent on the type of fuel. However, excess air beyond the optimum range (an efficient natural gas burner however requires 2% to 3% excess oxygen, or 10% to 15% excess air in the flue gas, to burn fuel without forming carbon monoxide) may substantially decrease combustion efficiency as it leads to generation of excessive waste gases. The effect of excess air level and flue gas temperature on dry flue gas losses is shown in graph

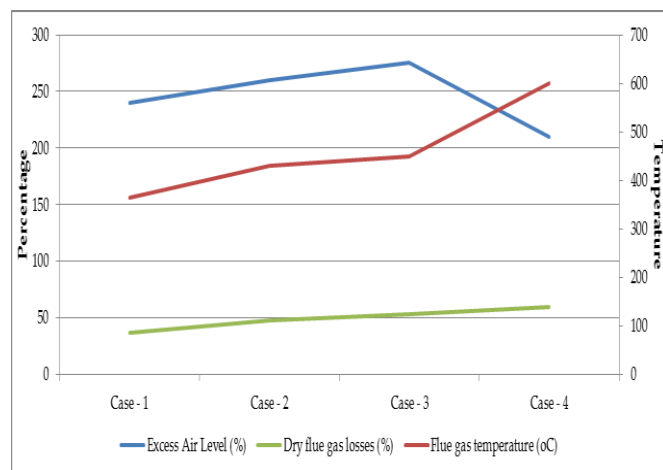

Excess air vs dry flue gas loss

The relationship between the air-to-fuel ratio and wasted heat energy provides a basis for control system design. In most of the cases, real combustion processes have inadequate mixing of air with fuel. Also, the gases tend to flow so quickly that the air and fuel mix have limited contact time in the combustion zone. As such, if air is fed in exact theoretical or stoichiometric proportion to the fuel, it will still lead to incomplete combustion. Automatic burner assembly generally performs in a manner similar to the graph. The cost associated with operating at increased air-to-fuel ratio is the energy wasted in heating additional air

volume. Yet, if the air-to-fuel ratio is decreased, losses due to incomplete combustion and emission will increase rapidly.

Too Little Air Increases Pollution and Wastes Fuel	Too Much Air Wastes Fuel
<p>↳ If the air-to-fuel ratio is too small, there will not be enough oxygen available to completely convert the hydrocarbon fuel to carbon dioxide and water. Too small air-to-fuel ratio leads to incomplete combustion of fuel. As the availability of oxygen decreases, noxious exhaust gases including carbon monoxide will be formed first. As the air-to-fuel ratio decreases further, partially burned and unburned fuel may appear in the exhaust stack, often revealing itself as smoke and soot.</p>	<p>↳ The issue that makes operation of a combustion process so interesting is that if feed air to the combustion zone is high (if the air-to-fuel ratio is too high), waste of fuel, though in a wholly different manner. Once enough oxygen available in the burn zone to complete combustion of fuel, it would have addressed the pollution portion of combustion chemistry equation. However, any air fed to the process above and beyond that amount becomes an additional process load to be heated.</p>
<p>↳ Incomplete combustion also means wasting expensive fuel. Fuel that does not burn to provide useful heat energy, including carbon monoxide that could yield energy as it converts to carbon dioxide, literally flows up to exhaust stack as lost profit.</p>	<p>↳ As the air-to-fuel ratio increases above that needed for complete combustion, the extra nitrogen and unneeded oxygen absorb heat energy, decreasing the temperature of flame and gases in combustion zone. As the operating temperature drops, less extraction of useful heat energy for intended applications.</p>

Kiln thermal parameters controller comprises kiln temperature, pressure and atmosphere controlling. In different stages, the control act differently, in firing process, PLC control inverter adjust the combustion fan to change air flowing in air hose. Electric valve of fire nozzle is set by numerical program to setup kiln atmosphere during heating process.

In the cooling stage, NG is shut down and each fire valves/nozzle is closed automatically. The temperature controller switch to the cooling control mode and the

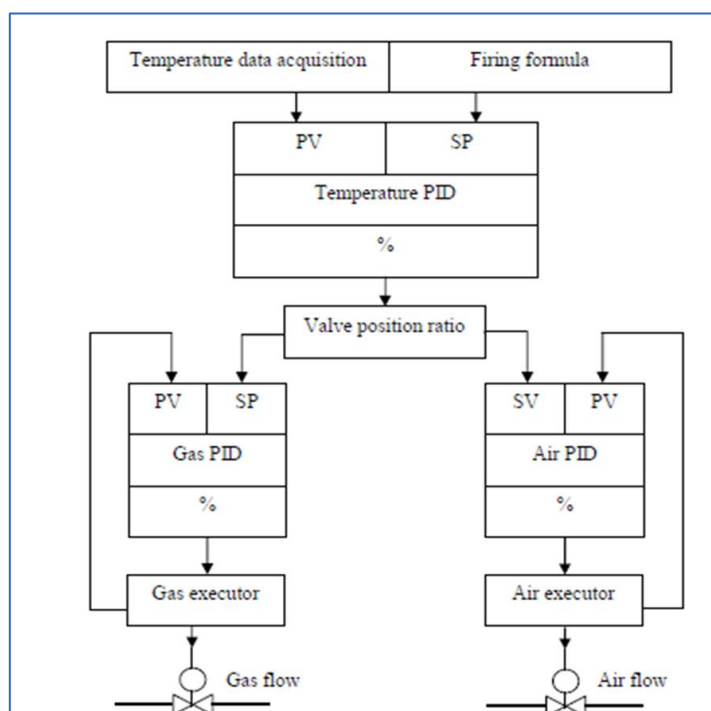

system enters cooling stage. In this period, air general pipe is controlled by opening degree.

Fire nozzles are divided into two groups. In order to reduce cost, temperature valve position automatic control is used as shown in Figure. Each gas general hose has gas solenoid valve and each group of gas general hose and combustion general hose is installed with electric executor. This compares the air-fuel ratio practical value (PV measured by thermocouples) with set value (SV) and controls gas executor and combustion executor by PID regulator. Temperature PID controller controls firing by controlling air flow and gas flow which are accomplished by the opening degree of combustion air valves and gas valves.

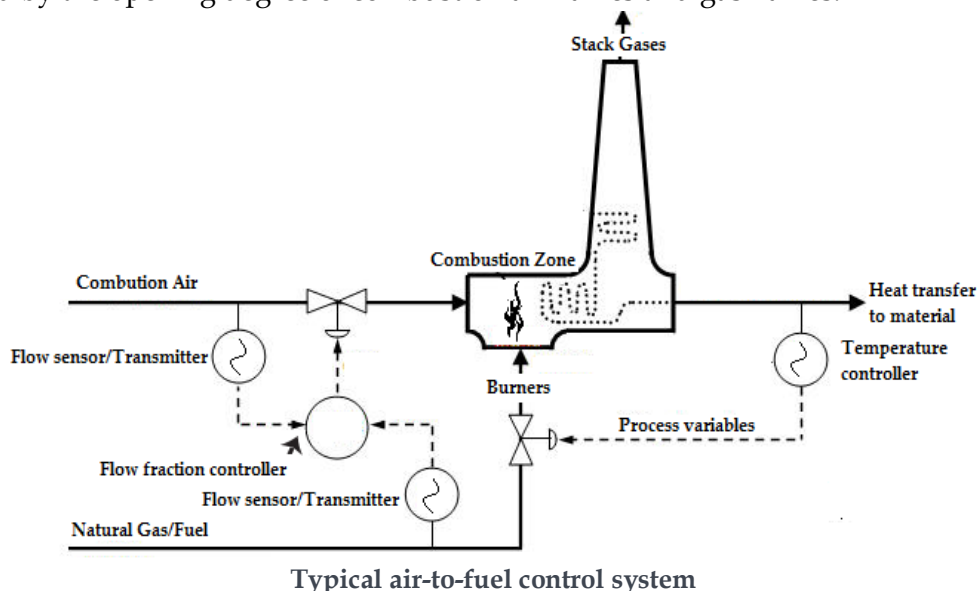

Benefits of combustion control

- Reduce excess fuel consumption.
- Reduce blower power consumption
- Increases exhaust temperature
- Give higher benefits in preheated combustion air as well as in dryer applications

Reduction of the excess air flow rate leads to a reduction in kiln energy consumption, though this operation must be performed with care, because other kiln operating parameters could be affected. It has been experimentally verified that 2% reduction in the oxidising air flow rate entails a decrease of the order of 5% in the natural gas flow rate.

Use of low thermal mass material

Heavy refractory cars and saggars are generally used for carrying ceramic products inside the kiln. The dead weight of the refractories is quite high (around 24%). These refractories which do not take part in reactions in formation of ceramic products, are subjected to alternate heating and

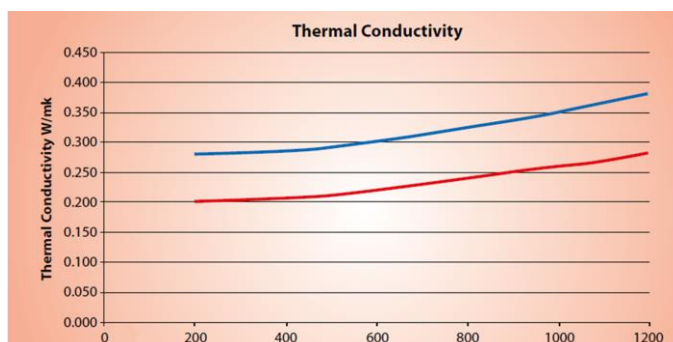

cooling cycles, thereby losing substantial portion of heat input. These heavier refractory cars and saggars can be replaced effectively with low thermal mass cars and decker plates (23 – 24 % weight reduction is possible), which would help in reducing heat losses substantially. The estimated energy saving with use of low thermal mass cars is about 5-10%.

- Use of low thermal mass for kiln cart to **reduces the thermal weight** of the kiln considerably
- Weight reduction in kiln car saves significant amount of energy and also **improve material to car weight ratio**
- Reduces excess the **thermal energy storage** in the kiln furniture (**Roller**)
- Ultralite insulating material with supporting block gives proper support and increase the strength of the kiln base
- Replacing refractory bricks with hollow ceramic coated pipes at the supporting pillars for holding racks
- Dead weight can be cut down to 15 to 25% of the existing weight

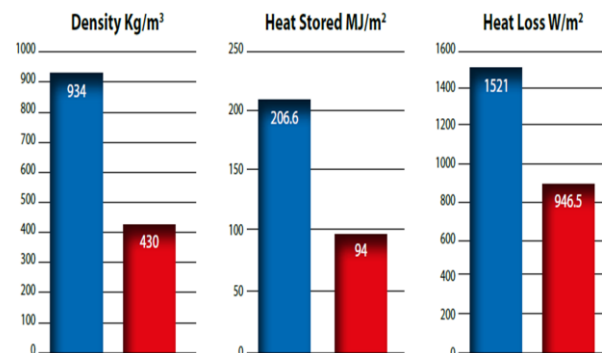

Advantages of ultralite insulating material

- High open porosity
- Low thermal mass
- Low permeability
- Low thermal conductivity
- Low bulk density
- Lightweight



Improved insulation and refractories of kiln

The efficiency of a kiln is directly dependent of the method of combustion and heat stored within the structure. Apart from the dry flue gas losses, a substantial amount (8–13%) of heat is also lost from walls and material charging and discharging ends. The heat loss from structure can be divided into (i) radiation loss through openings and surface of the body, (ii) loss through roller/car, (iii) heat accumulation loss to internal insulation and supports composing the body. The heat accumulation loss can be ignored for a continuous operation kiln having minimal change in the operating temperature.

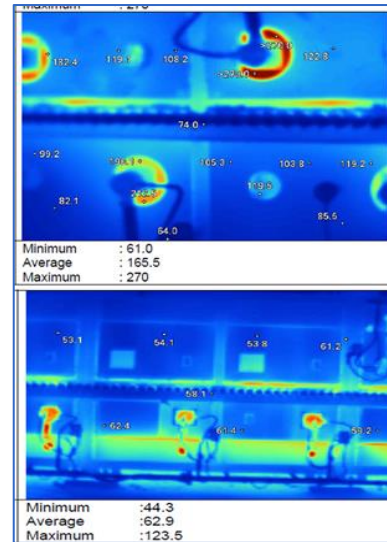

Improvement in the radiation heat loss from surfaces can be achieved by reinforcing its insulation. This includes (i) covering of internal wall surface with ceramic fibre insulation, and (ii) covering external wall surface with ceramic fiber or rock wool insulation.

The temperature gradient i.e. difference between the hot face temperature (hot face temperature is the temperature of the refractory surface in contact with the flue gas or heated combustion air) and surface temperature will be a critical factor for reduction in heat loss by reinforcement of insulation. The hot face temperature is used to determine refractory or insulation thickness and heat transmitted. The design temperature is used to specify the service temperature limit of refractory materials.

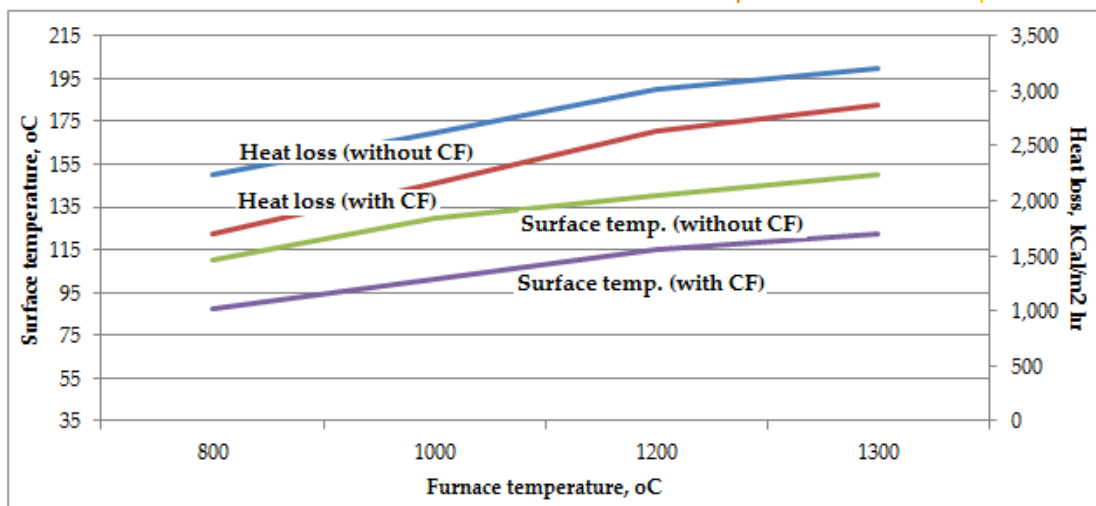
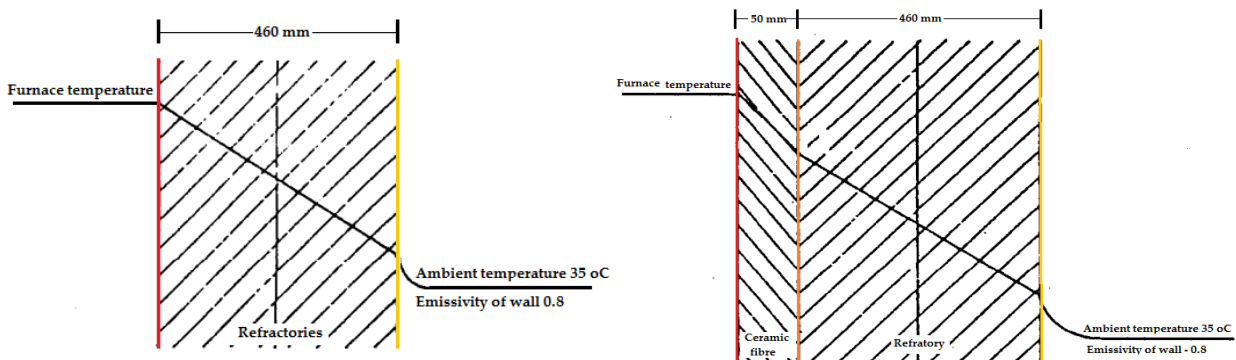

Effect of insulation in a kiln: Heat loss vs surface temperature

Use of better insulation material would further help in improving the thermal efficiency of kilns. The overall energy saving potential of kilns is about 2–3%.

Waste heat recovery in kiln

In the existing practices, the quantity of heat taken away from a kiln by high temperature flue gases is quite large. This can be reduced by adopting two methods, one is to reduce the volume of exhaust gas, and the other is to reduce the temperature of exhaust gas. The former is optimization of air-fuel ratio. The second method is through recovering waste heat available in outgoing flue gas. One of the conventional, economical and convenient methods is use of centralized recuperator system for preheating of combustion air.

Recuperator is a mechanical device in which heat exchange takes place between the flue gases and the combustion air through metallic or ceramic walls. Ducts or tubes carry the air for combustion for preheating whereas the other side contains the waste heat (flue gas) stream. There are many types of the waste heat recovery recuperator depending on the application. The most common types of recuperator include metallic radiation recuperator, convection recuperator, hybrid recuperator and ceramic recuperator.

The most commonly recuperator used is convection type. Convection recuperator (also referred to as “flue” or “canal” recuperator) is tubular heat exchangers that utilize convection heat transfer to preheat combustion air for the purpose of saving fuel. By recovering heat from the hot waste gas exiting the kiln and transferring it to combustion air feeding the burners, fuel usage can be reduced up to 5-15%.

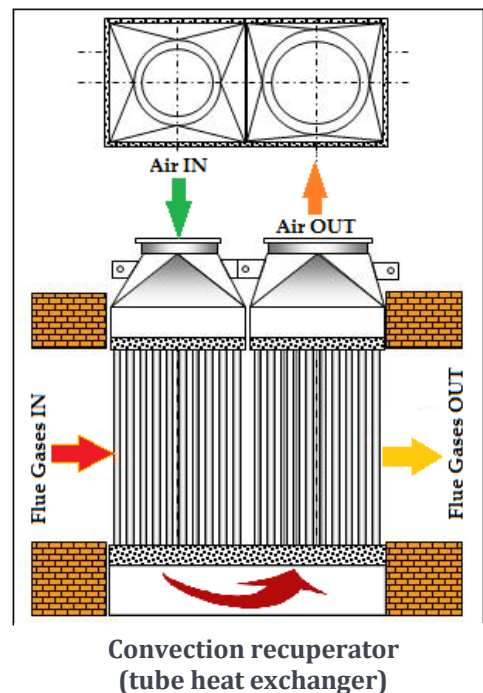

Use of energy efficient & high preheated air temperature burners

Use of high velocity energy efficient burner's and high preheated air temperature burners further improves kiln efficiency. Observed maximum preheated air temperature in the kiln in Thangadh cluster is 250 °C, whereas current burner technology accepts air preheat temperature upto 600 °C. This offers good opportunity for high temperature waste heat recovery. Higher the combustion air temperature, lower will be the fuel consumption in the kiln.

(Source: Manual on Energy Conservation Measures in Ceramic Industry, BEE SME Programme)

4.1.5 Other key recommendations/tools

Optimum capacity utilization

The capacity utilization (commonly known as “loading”) of a kiln is one of the key factors affecting the efficiency. The loading of a kiln includes preparation of material to feed, amount of material placed, arrangement inside the kiln and the residence time inside the kiln.

Optimum arrangement of load

The feedstock on the hearth should be arranged in such a manner that:

- ✓ It receives maximum amount of radiation from the hot surfaces of the heating chambers and flames
- ✓ Hot gases are efficiently circulated around the heat receiving surfaces of the materials

Stock should not be placed in the following positions:

- ☒ In the direct path of the burners or where impingement flame is likely to occur
- ☒ In an area that is likely to cause a blockage or restriction of the flue system of the kiln
- ☒ Close to any door openings where cold spots are likely to develop

Raw Material Processing

- ✓ Purchase the right materials, it will save the energy and costs that would otherwise have to be incurred to treat them in the unit
- ✓ Raw material is transported to the processing areas by conveyers: do not let the conveyor ON when there is no material to be transported.
- ✓ Fit timer switches on all the grinding machines so that they automatically switch off after processing of the raw material

5.0 Module 4 – Financing schemes and DPR preparation for EE projects

5.1 Introduction

Energy efficiency projects may be identified by either internal expert or hired external agency through day to day performance monitoring and analysis of observed data. The identified projects are to be screened for technical and financial viability before deciding to implement any project demanding higher capital investment. It is essential to justify capital investment in any energy efficiency project through financial appraisal. The standard financial analysis tools can reveal status of various indicators such as IRR (internal rate of return), NPV (net present value), projected cash flow and its sensitivity to various changing scenarios, average payback period, etc., which will indicate overall post tax return from investment as well as the viability of the project

All these tools are quite reliable, depending on the accuracy of evaluation of the cash inflow and outflow, estimation of the discount rate (cost of capital), and prediction of the possible rate of increase of the energy price. Within these limitations, the most precise method is the 'present value criterion', which compares the present value of all-future after-tax cash inflow and outflow over specified period of time to the present value of the cost of investment. The different financial tools for assessment of the investments are summarized below.

5.1.1 Average rate of return (ARR)

It is a basic tool for financial analysis based on the projected future annual cash savings from the project, which is considered to be same. It provides a preliminary guide to investment decisions and indicates whether further analysis is required using more accurate tools. The estimation of ARR is described with the following example.

Example: Plant invested Rs 950,000 to replace existing compressor with alternative system to improve energy performance. The estimated year wise saving in energy cost for a period of five years are Rs 65,000 in the first year, Rs 71,000 in the second year, Rs 69,000 in the third year, Rs 70,000 in the fourth year, and Rs 72,000 in the fifth year. The total cumulative energy savings in five years is Rs 347,000. Dividing this number by the 5 years, we get Rs 69,400 as an average annual energy savings. Now to obtain ARR, divide Rs 69,400 by the initial capital investment of Rs 950,000, which is equal to 7.3%.

$$ARR (\%) = \frac{\text{average annual cash saving} \times 100}{\text{capital employed}}$$

Guideline- Invest in a project with higher ARR

5.1.2 Return on investment (ROI)

ROI is a profitability measure based on the cost of capital invested and evaluates the performance of a business or efficiency of an investment. The ROI of an investment can be calculated using following relation.

$$ROI (\%) = \frac{(Gain\ from\ investment - Cost\ of\ investment) \times 100}{Capital\ employed}$$

The 'gain from investment' refers to energy savings accrued from implementing an EE technology. The financial gain is to be estimated based upon the discounted value of the energy savings over the life time of the project. Return on investment is a very popular measure because of its versatility and simplicity. The project is considered to be financially viable if ROI from an investment is positive.

Discounted value of energy savings

Discounted value is an analysis based on time value for money (considering money is relative - A Rupee is worth more today than it is worth in the future). So the energy savings over the years have to be discounted to obtain their present value.

Guideline: Invest in a project with higher ROI

5.1.3 Simple payback period (SPP)

SPP is the time period required to recover the initial capital investment amount through net annual energy savings or cash flow return (annual benefits- annual expenses). It is calculated as the investment cost divided by the net annual energy saving.

$$Simple\ payback\ period\ (SPP\ in\ years) = \frac{Cost\ of\ project}{Net\ annual\ monetary\ savings}$$

Unlike the ROI method, the payback criterion has some limitations as it does not take into consideration the discount rate, the change in energy prices, or the lifetime of the investment project. It has one advantage over ROI in respect of precise indication of the annual benefit, namely the cash flow instead of profits. However, both suffer from the difficulty in justifying the threshold value beyond which no project should be considered. In practice, investment projects with a payback period of three years or less are considered viable as they normally have a positive net present value. Thus the payback period is often used as a "filter", calculating NPV when the payback period is over three years and accepting the project when it is less. The advantages of SPP are as follows.

- It is a simple calculation and easy to use by semi-skilled shop floor personnel
- It favours projects with substantial cash flow in initial years but rejects projects that generates substantial cash flow in later years instead of earlier

The limitations of SPP tool are:

- It fails to account for the time value of money
- It ignores potential cash flow beyond the payback period
- It only indicates time period to recover capital investment but ignores profitability

Guideline: Invest in a project with small SPP

5.1.4 Net Present Value (NPV)

The net present value (NPV) is the present value of the entire cash flow considering both out flow and inflow (energy savings) from a project under analysis in entire project life cycle, including any residual or salvage value of the equipment on disposal/ completion life cycle. In simple terms, the difference between the present value of energy savings (inflows) and the present value of cash outflows is NPV.

It is calculated using a given discount rate, also known as the hurdle rate and is usually equal to the incremental cost of capital. NPV is very useful analysis that enables the plant management to take an informed decision about whether to accept or reject a particular project. Project could be accepted if its NPV is more than zero, which indicates the investment would add value to the firm. In case of zero NPV, project could still be accepted if it has some strategic value for the firm. However, the project with negative NPV would subtract value from the firm and hence, should be rejected. The future energy savings are converted to present value using following formulae.

$$PV = \frac{FV}{(1 + i)^n}$$

Where,

FV - future value of energy savings

i - interest or discount rate or hurdle value

n - number of years under analysis

The NPV is then calculated by subtracting the initial cost of investment from the total PV of future energy saving from entire life cycle:

NPV = total PV- Initial cost of investment

NPV indicates the return that the management can expect from the project at various discount rates. It can also be used to compare various EE projects with similar discount rates and risks, as well as compare them against a benchmark rate. The advantages of NPP are given below.

- It consider the time value of money
- It consider entire cash flow stream during project life cycle including salvage value

Guideline:

NPV > 0 : Should be accepted

NPV = 0 : Should be accepted if the project has some strategic value

NPV < 0 : Should not be accepted

5.1.5 Internal rate of return (IRR)

IRR also referred as 'economic rate of return' is the highest discounted rate, which makes the present value of the energy savings / inflows (including residual or salvage value of the equipment from its life cycle) equal to the initial capital cost of the investment or equipment. In other terms, internal rate of return is the discount rate that makes the net present value equal ZERO. It is also the rate, which makes benefits to cost ratio ONE. A project is considered viable, if its IRR is greater than the returns (interest rate) offered by the bank/ financial institution on investments/ deposits made with them.

The formula for IRR is

$$0 = \frac{P_0 + P_1}{(1 + IRR)} + \frac{P_2}{(1 + IRR)^2} + \frac{P_3}{(1 + IRR)^3} + \dots + \frac{P_n}{(1 + IRR)^n}$$

where P_0, P_1, \dots, P_n equals the cash flows in periods 1, 2, . . . n, respectively; and IRR equals the project's internal rate of return.

As such, IRR can be used to rank several prospective projects a firm is considering. Assuming all other factors are equal among the various EE projects, the EE project with the highest IRR would probably be considered the best and undertaken first.

Guideline: Invest in a project with high IRR

5.2 Major financial schemes for MSMEs in India

The Government of India and respective State governments have announced various policies and schemes from time to time to address emerging issues and develop the MSME sector.

Most of the programmes & schemes for the development of the MSME sector are being implemented by Ministry of MSME through its field level organizations – state level MSME Development Institutes (MSME-DI) and National Small Industries Corporation Limited (NSIC).

Some of the important initiatives by the Government of India for development of the MSME sector as well as promotion of new technologies and energy efficiency are mentioned below.

- National Manufacturing Competitiveness Programme (NMCP)
- Credit Linked Capital Subsidy Scheme (CLCSS)

- Credit Guarantee Trust for MSEs ISO 9000 and ISO 14001 Certification Reimbursement Scheme
- Financial Assistance for using Global Standard(GS1) in Barcoding
- Sustainable Finance Scheme
- Subsidies/schemes for undertaking energy audits by various state governments such as Maharashtra, Gujarat etc.

5.2.1 National Manufacturing Competitiveness Programme (NMCP)

The programme was launched by the Ministry of MSME (MoMSME) to support SMEs to improve their competitiveness both in national and international trade market. It offers a bundle of 10 sub schemes that are listed below:

1. Lean Manufacturing Competitiveness Scheme
2. Enabling manufacturing sector to be competitive through Quality Management/Standards/Quality Technology Tools (QMS/QTT)
3. Promotion of ICT (Information and Communication Technology) in MSME sector
4. Technology and Quality Upgradation Support to MSMEs (TEQUP)
5. Marketing Assistance and Technology Upgradation Scheme
6. Marketing Support/ Assistance to SMEs (Bar Code)
7. Design clinic scheme for design expertise to MSME sector
8. Setting up of Mini Tool Rooms
9. National campaign for building awareness on Intellectual Property Rights (IPR)
10. Support for Entrepreneurial and Managerial Development of SMEs through Incubators

The relevant scheme for supporting EE project is TEQUP Scheme, which is summarized below.

The MoMSME launched the scheme TEQUP scheme during May 2010. The scheme under NMCP is focused specifically on improving energy efficiency in the MSME sector. It provides support for technical assistance for energy audits, preparation of DPRs and also offers significant capital subsidy to MSME units willing to adopt energy efficient technologies through a cluster approach. In addition, support is also offered to MSMEs in acquiring international and national Product Quality Certification. The scheme also provides MSMEs an opportunity to trade carbon credits through Carbon Credit Aggregation (CCA) centers. The TEQUP scheme is currently in operation, and the government has proposed to continue the scheme during the 12th Plan with enhanced budgetary support.

5.2.2 CLCSS Scheme

The CLCSS. One of the oldest schemes of MoMSME, it aims at facilitating technology upgradation in the MSME sector. It provides for 15% capital subsidy (limited to maximum Rs.15 lakhs) to eligible micro and small units for adoption of proven technologies approved under the scheme. At present there are over 1500 technologies under 51 sub-sectors that are

eligible for subsidy under the scheme. Till March 2014, 28,287 units had availed subsidy of INR 1620 crores under the scheme.

5.2.3 Credit Guarantee Scheme

The Credit Guarantee Fund Scheme for Micro and Small Enterprises (CGTMSE) was launched by MoMSME and SIDBI. It aims to make available collateral-free credit to the MSEs to enable them to easily adopt new technologies. Both the existing and the new enterprises are eligible to be covered under the scheme. Under the scheme, collateral free loans up to 1 crores can be provided to micro and small scale units. Additionally, in the event of a failure of the MSME unit which availed collateral free credit facilities to discharge its liabilities to the lender, the Guarantee Trust would guarantee the loss incurred by the lender up to 75 / 80/ 85 per cent of the credit facility.

5.2.4 Scheme for Common facilities Center (CFC) in industrial cluster

The brief details of the scheme are mentioned below.

Operating authority - The office of Development Commissioner, MoMSME

Eligibility criteria - SPV comprising at least 25 registered located in the cluster

Financial support - 70 % by Central Government and balance 30 % by SPV /State government for project value up to Rs 15 Crores.

The cluster members can apply through the State government or its autonomous body for DSR (Diagnostic Study Report) for which a grant of up to Rs 2.5 Lakhs is available. The report must be submitted within 3 months to DC MSME which will justify the creation of CFC. On acceptance of the DSR by DCMSME, a DPR is to be submitted for which a funding of Rs 5 Lakhs is available. The DPR, which needs to be appraised by SIDBI establishes the tech-economic viability of the project .On acceptance of the DPR the financial grant to set up the CFC is released to the SPV through the state government.

5.3 Various credit lines and bank schemes for financing of EE

There are several special lines of credit under which loans are provided to MSMEs at reduced rate of interest for adoption of clean and energy efficient technologies. SIDBI is the nodal agency for management and implementation of these lines of credit. More details related to existing credit lines and its scope of services is available with SIDBI. Some of these schemes are mentioned below.

- JICA - SIDBI financing scheme
- KfW - SIDBI financing scheme
- AfD - SIDBI financing scheme
- Sustainable Finance Scheme (SFS)

5.4 Preparation of detailed project report (DPR)

The guidelines to prepare DPRs for seeking loans from banks for the capital expenditures for implementing viable energy efficiency project are provided below.

Detailed financial analysis of the moderate to large investments is required as much for the promoter, as it is for the banker. The promoter is interested to see if the true return on the investment over the project life is comparable to returns on other sources of investment, such as a fixed deposit in a bank, while the banker needs to be convinced on the financial viability of the investment made through the loan. In general, each DPR on EE project is to be structured to include the company profile, energy baseline assessment, technology assessment, financial assessment and sustainability assessment.

The company profile of the unit will include assessment of its past financial reports (balance sheet, profit and loss account), registration details, compliance with pollution control board norms, as well as, details of products, production capacities, customers, and marketing and selling arrangements.

Similarly, the energy baseline assessment will include current energy bill, cost of energy as a percentage of total manufacturing cost, and overall and section-wise specific energy consumption levels.

Technology assessment will include the details of the design of equipment/ technology along with the calculation of energy savings. The design details of the technology for EE project will include detailed engineering drawing for the most commonly prevalent operational scale, required civil and structural work, system modification, and included instrumentation and various line diagrams. A list of vendors (technology providers/ equipment suppliers) will be provided along with quotations for major bought-out equipment. Examples of similar interventions as proposed in other industries within India or abroad with the benefits will also be provided. The estimated lead time for implementation of the new technology, or enhancement of the existing technology will be provided.

The financial assessment will contain details of investment required for each EE measure and means of financing for the proposed measures. Financial projects such as cost-benefit analysis for each of the proposed measure and for the unit as a whole including IRR and cash flow will be provided.

The sustainability assessment will include environmental and social sustainability assessments like Green House Gas (GHG) reduction (over the estimated lifetime in terms of certified emission reductions or CERs), reduction in conventional pollutants; air (sulphur dioxide, particulates etc.), water and solid waste, productivity enhancements and social impacts on the workforce.

A typical outline of the content page of a DPR is provided in table 5.4. It is understood that the DPRs will be structured keeping in view their acceptability to financial institutions/banks.

Table 5.4: Typical contents page of DPR

Executive Summary	
1.0	Introduction
1.1	Brief introduction about cluster/ unit
1.2	Energy performance in existing situation
1.3	Proposed EE intervention
1.3.1	Description of existing technology/ equipment
1.3.2	Energy audit methodology
1.3.3	Performance analysis of the existing technology
1.4	Barrier analysis in adoption of proposed EE intervention
2.0	Implementation methodology
2.1	Approach of modification
2.2	Description of modified system/ equipment
2.3	Availability of equipment
2.4	Source of equipment
2.5	Terms and conditions in sales of equipment
2.6	Process down time during implementation
2.7	Life cycle assessment and risks analysis
2.8	Suitability of unit for implementation of proposed technology
3.0	Benefits from proposed EE intervention
3.1	Technical benefit
3.2	Monetary benefits
3.3	Social benefits
3.4	Environmental benefits
3.5	Examples of similar interventions
4.0	Project Financial Statements
4.1	Cost of project and means of finance
4.2	Financial projections of the unit
4.2.1	Projected financial summary of the unit
4.2.2	Projected operating statement of the unit
4.2.3	Projected balance sheet of the unit
4.2.4	Projected cash flow statement of the unit
4.2.5	Projected fund flow statement of the unit
4.2.6	Projections of current assets and current liabilities of the unit
4.2.7	Debt Service Coverage Ratio
4.2.8	Debt Equity Ratio
4.2.9	Other major financial ratio calculations
4.2.10	Maximum permissible bank finance for working capital as per Nayak Committee
4.2.11	Working capital requirements
4.2.12	Assumptions for financial calculations
4.2.13	Marketing & Selling arrangement

4.2.14	Risk analysis and mitigation
4.2.15	Conclusion
Typical Appendices	
	Process flow diagram
	Baseline energy performance
	Schematic diagram of the modified system
	Technical specification and information brochure of equipment
	Details of fabricators/ suppliers
	Budgetary quotation for the proposed equipment
	Cash flow and financial analysis
List of used abbreviations	

5.5 Step by step approach for loan application

Energy efficiency projects are normally supported by banks and financial institutions under the broad umbrella of various government schemes and credit lines. These schemes and credit lines are formulated with specific eligibility criteria to promote special thematic issues for improving overall business sustainability of the target sector.

Loan application for EE projects is to be developed using standard format of individual scheme guidelines or credit line requirements. It is advisable for the concerned MSME unit to obtain the standard template of loan application from the prospective banking institute, which is going to evaluate loan application before granting financial support. The following activities are required to be undertaken for developing loan application to seek financial support from bank towards implementation of EE projects by the unit.

- Establish baseline performance through detailed study
- Identify implementable energy conservation measures (ECMs) including alternative energy efficient (EE) technologies wherever applicable
- Prepare preliminary cost-benefit analysis
- Identify suitable technology suppliers who can also provide regular maintenance
- Obtain techno commercial quotations
- Negotiate price and finalize suppliers
- Estimate miscellaneous costs for implementation of ECMs
- Estimate project cost and means of finance
- Undertake the financial projections of the unit
- Identify eligible financing scheme and credit line for financial support
- Discuss the EE project with the prospective financial institution (FI)
- Develop detailed project report as per the guidelines provided and format of the scheme that includes baseline monitoring and verification (M&V) protocol
- Submit the DPR to the FI for review
- Follow up with the FI and provide clarification if any
- Obtain loan approval and complete necessary contract with concerned FI
- Implement the project that includes commissioning, trial runs and troubleshooting required if any

- Undertake post implementation M & V protocol
- Submit status report to FI as per the agreement